

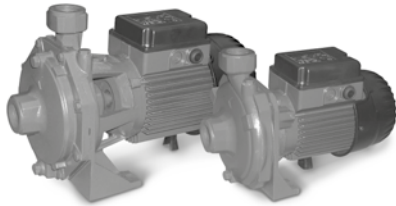

TARIFA 2-2021

PRICE LIST 2-2021

	TIPO TYPE	CV HP	PVP € BOMBA/Pump
--	--------------	----------	---------------------

K

K 5 M	0,5	286,00
K 5 T	0,5	278,00
K 8 M	1	373,00
K 8 T	1	391,00
K 10 M	1	448,00
K 10 T	1	463,00
K 15 M	1,5	538,00
K 15 T	1,5	562,00
K 17 M	1,5	580,00
K 17 T	1,5	608,00
K 20 M	2,5	600,00
K 20 T	2,5	571,00
K 25 M	2,5	694,00
K 25 T	2,5	675,00
K 30 T	3	1.080,00
K 31 T	3	897,00
K 40 T	4	1.216,00
K 41 T	4	925,00
K 55 T	5,5	1.266,00
K 56 T	5,5	1.084,00
K 75 T	7,5	2.529,00
K 100 T	10	2.686,00
K 125 T	12,5	3.298,00
K 150 T	15	3.425,00

**KI - AISI 304**

KI 12 M INOX	1	423,00
KI 16 M INOX	1,3	524,00
KI 16 T INOX	1,3	524,00
KI 22 M INOX	2	689,00

**CB**

CB 100 M	1	384,00
CB 100 T	1	384,00
CB 160 M	1,5	528,00
CB 160 T	1,5	513,00
CB 210 M	2,2	584,00
CB 210 T	2,2	560,00
CB 310 T	3	569,00
CB 400 T	4	1.047,00
CB 600 T	5,5	1.083,00
CB 750 T	7,5	1.382,00

	TIPO TYPE	CV HP	PVP € Motor IE3
--	--------------	----------	--------------------

MN

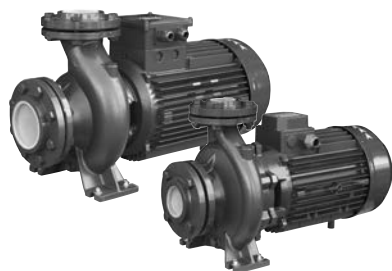

MN 32-160 C Monofásica	2		841,00
MN 32-160 C	2		835,00
MN 32-160 B	3		854,00
MN 32-160 A	4		885,00
MN 32-200 C	5,5		1.116,00
MN 32-200 B	7,5		1.477,00
MN 32-200 A	10		1.556,00
MN 32-250 C	12,5		1.876,00
MN 32-250 B	15		1.971,00
MN 32-250 A	20		3.042,00

MN 40-125 C Monofásica	2		876,00
MN 40-125 C	2		865,00
MN 40-125 B	3		887,00
MN 40-125 A	4		916,00
MN 40-160 B	4		1.047,00
MN 40-160 A	5,5		1.083,00
MN 40-200 B	7,5		1.482,00
MN 40-200 A	10		1.561,00
MN 40-250 B	15		1.941,00
MN 40-250 A	20		3.015,00

MN 50-125 B	4		1.045,00
MN 50-125 A	5,5		1.081,00
MN 50-160 B	7,5		1.474,00
MN 50-160 A	10		1.552,00
MN 50-200 C	12,5		1.791,00
MN 50-200 B	15		1.885,00
MN 50-200 A	20		2.966,00
MN 50-250 C	20		3.054,00
MN 50-250 B	25		3.422,00
MN 50-250 A	30		3.615,00

MN 65-125 B	7,5		1.517,00
MN 65-125 A	10		1.595,00
MN 65-160 C	12,5		1.799,00
MN 65-160 B	15		1.891,00
MN 65-160 A	20		2.966,00
MN 65-200 C	20		3.054,00
MN 65-200 B	25		3.419,00
MN 65-200 A	30		3.615,00

MN 80-160 D	15		1.991,00
MN 80-160 C	20		3.059,00
MN 80-160 B	25		3.425,00
MN 80-160 A	30		3.620,00

PARA VOLTAGES ESPECIALES,
LOS PRECIOS INDICADOS SE
INCREMENTARAN UN 4%

FOR SPECIAL VOLTAGES, THE
PRICES WILL BE INCREASED 4%

Voltaje habitual para Potencias hasta 5,5 HP 230-400V a partir de 7,5 HP 400/690V
Standard Voltage up to 5,5 HP- 230/400V from 7,5 HP 400/690V

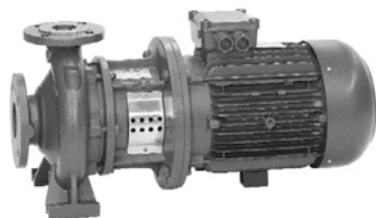
TIPO
TYPE
CV
HP
PVP €
Motor IE-3
NKM-G - 1.450 RPM CON ACOPLAMIENTO

1.450 R.P.M.

NKM-G 32-125.1/140	0,33	1.113,00
NKM-G 32-125 /142	0,5	1.123,00
NKM-G 32-160.1/169	0,5	1.266,00
NKM-G 32-160/169	0,75	1.297,00
NKM-G 32-200.1/200	0,75	1.405,00
NKM-G 32-200/200	1	1.462,00
NKM-G 32-200/219	1,5	1.516,00
NKM-G 40-125/115	0,33	1.216,00
NKM-G 40-125/130	0,5	1.225,00
NKM-G 40-125/142	0,75	1.254,00
NKM-G 40-160/153	0,75	1.362,00
NKM-G 40-160/166	1	1.520,00
NKM-G 40-200/200	1,5	1.635,00
NKM-G 40-200/219	2	1.656,00
NKM-G 40-250/245	3	2.063,00
NKM-G 40-250/260	4	2.084,00
NKM-G 50-125/130	0,75	1.463,00
NKM-G 50-125/141	1	1.520,00
NKM-G 50-160/161	1,5	1.601,00
NKM-G 50-160/177	2	1.621,00
NKM-G 50-200/210	3	1.857,00
NKM-G 50-200/219	4	1.879,00
NKM-G 50-250/263	5,5	2.257,00
NKM-G 65-125/130	1	1.591,00
NKM-G 65-125/144	1,5	1.644,00
NKM-G 65-160/153	1,5	1.689,00
NKM-G 65-160/165	2	1.709,00
NKM-G 65-160/177	3	1.794,00
NKM-G 65-200/210	4	2.156,00
NKM-G 65-200/219	5,5	2.254,00
NKM-G 65-250/263	7,5	2.984,00
NKM-G 65-315/279	10	3.518,00
NKM-G 65-315/309	15	4.118,00
NKM-G 80-160/153	2	1.927,00
NKM-G 80-160/163	3	2.012,00
NKM-G 80-160/177	4	2.034,00
NKM-G 80-200/200	5,5	2.579,00
NKM-G 80-200/222	7,5	2.774,00
NKM-G 80-250/240	10	3.628,00
NKM-G 80-250/270	15	4.228,00
NKM-G 80-315/305	20	4.475,00
NKM-G 80-315/320	25	4.936,00
NKM-G 80-315/334	30	5.069,00
NKM-G 100-200/200	7,5	3.125,00
NKM-G 100-200/214	10	3.227,00
NKM-G 100-250/250	15	4.402,00
NKM-G 100-250/270	20	4.538,00
NKM-G 100-315/300	25	5.213,00
NKM-G 100-315/316	30	5.415,00
NKM-G 125-250/243	20	4.693,00
NKM-G 125-250/256	25	5.154,00
NKM-G 125-250/266	30	5.287,00
NKM-G 150-200/218	15	5.565,00

Voltaje habitual para Potencias hasta 5,5 HP 230-400V a partir de 7,5 HP 400/690V
 Standard Voltage up to 5,5 HP- 230/400V from 7,5 HP 400/690V

	TIPO TYPE	CV HP	PVP € Motor IE-3
--	--------------	----------	---------------------

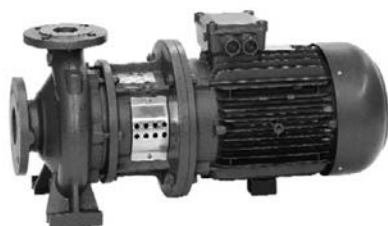
NKP-G 2,900 R.P.M. CON ACOPLAMIENTO



2.900 R.P.M.

NKP-G 32-125.1/102	1	1.230,00
NKP-G 32-125.1/115	1,5	1.262,00
NKP-G 32-125.1/125	2	1.293,00
NKP-G 32-125.1/140	3	1.336,00
NKP-G 32-125/110	1,5	1.262,00
NKP-G 32-125/120	2	1.293,00
NKP-G 32-125/130	3	1.336,00
NKP-G 32-125/142	4	1.544,00
NKP-G 32-160.1/155	3	1.451,00
NKP-G 32-160.1/166	4	1.579,00
NKP-G 32-160/151	4	1.579,00
NKP-G 32-160/163	5,5	1.663,00
NKP-G 32-160/177	7,5	2.037,00
NKP-G 32-200.1/188	5,5	1.968,00
NKP-G 32-200.1/205	7,5	2.129,00
NKP-G 32-200/190	7,5	2.129,00
NKP-G 32-200/210	10	2.315,00
NKP-G 40-125/107	2	1.396,00
NKP-G 40-125/120	3	1.440,00
NKP-G 40-125/130	4	1.647,00
NKP-G 40-125/139	5,5	1.726,00
NKP-G 40-160/158	7,5	2.139,00
NKP-G 40-160/172	10	2.324,00
NKP-G 40-200/210	15	2.904,00
NKP-G 40-250/230	20	3.090,00
NKP-G 40-250/245	25	3.291,00
NKP-G 40-250/260	30	3.643,00
NKP-G 50-125/115	4	1.878,00
NKP-G 50-125/125	5,5	1.968,00
NKP-G 50-125/135	7,5	2.250,00
NKP-G 50-125/144	10	2.417,00
NKP-G 50-160/153	10	2.390,00
NKP-G 50-160/169	15	2.904,00
NKP-G 50-200/200	20	3.062,00
NKP-G 50-200/210	25	3.264,00
NKP-G 50-200/219	30	3.617,00
NKP-G 50-250/230	30	3.702,00
NKP-G 50-250/257	40	4.486,00
NKP-G 65-125/120/110	5,5	2.054,00
NKP-G 65-125/127	7,5	2.257,00
NKP-G 65-125/137	10	2.438,00
NKP-G 65-160/157	15	2.975,00
NKP-G 65-160/173	20	3.059,00
NKP-G 65-200/190	25	3.368,00
NKP-G 65-200/200	30	3.720,00
NKP-G 65-200/219	40	4.482,00
NKP-G 80-160/147/127	15	3.102,00
NKP-G 80-160/153	20	3.185,00
NKP-G 80-160/163	25	3.388,00
NKP-G 80-160/169	30	3.741,00
NKP-G 80-200/190	40	4.879,00

Voltaje habitual para Potencias hasta 5,5 HP 230-400V a partir de 7,5 HP 400/690V
Standard Voltage up to 5,5 HP- 230/400V from 7,5 HP 400/690V

TIPO TYPE	PVP € BOMBA/Pump
--------------	---------------------

KDN - EJE LIBRE

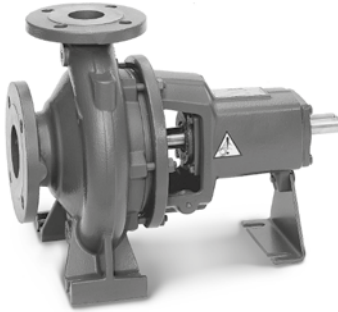

KDN 32-125.1	1.399,00
KDN 32-125	1.408,00
KDN 32-160.1	1.465,00
KDN 32-160	1.478,00
KDN 32-200.1	1.562,00
KDN 32-200	1.571,00
KDN 40-125	1.493,00
KDN 40-160	1.562,00
KDN 40-200	1.627,00
KDN 40-250	1.760,00
KDN 50-125	1.568,00
KDN 50-160	1.614,00
KDN 50-200	1.667,00
KDN 50-250	1.806,00
KDN 65-125	1.632,00
KDN 65-160	1.655,00
KDN 65-200	1.780,00
KDN 65-250	2.294,00
KDN 65-315	2.750,00
KDN 80-160	1.808,00
KDN 80-200	2.113,00
KDN 80-250	2.589,00
KDN 80-315	2.955,00
KDN 100-200	2.454,00
KDN 100-250	2.762,00
KDN 100-315	3.219,00
KDN 125-250	3.152,00
KDN 150-200	4.118,00

TIPO TYPE	CV HP	PVP € Motor IE-3
--------------	----------	---------------------

KDN - COMPLETA CON MOTOR SOBRE BANCADA A 2.900 R.P.M.

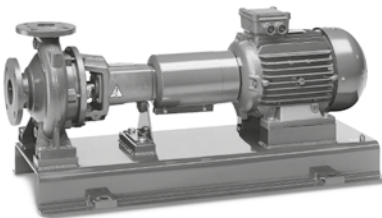

2.900 R.P.M.

KDN 32-125 1	1	2.274,00
2.900 R.P.M.	1,5	2.306,00
	2	2.337,00
	3	2.380,00
	4	2.597,00
	5,5	2.698,00
KDN 32-125	1,5	2.314,00
2.900 R.P.M.	2	2.346,00
	3	2.389,00
	4	2.606,00
	5,5	2.708,00
KDN 32-160 1	1,5	2.372,00
2.900 R.P.M.	2	2.403,00
	3	2.446,00
	4	2.663,00
	5,5	2.764,00
	7,5	2.995,00
KDN 32-160	3	2.457,00
2.900 R.P.M.	4	2.676,00
	5,5	2.777,00
	7,5	3.006,00
	10	3.173,00

	TIPO TYPE	CV HP	PVP € Motor IE-3
--	--------------	----------	---------------------

**KDN - COMPLETA CON MOTOR SOBRE BANCADA
A 2,900 R.P.M.**

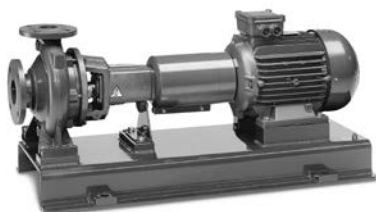

2.900 R.P.M.

KDN 32-200 1 2.900 R.P.M.	3	2.541,00
	4	2.760,00
	5,5	2.861,00
	7,5	3.092,00
	10	3.257,00
KDN 32-200 2.900 R.P.M.	4	2.769,00
	5,5	2.870,00
	7,5	3.100,00
	10	3.266,00
	15	3.837,00
KDN 40-125 2.900 R.P.M.	20	3.946,00
	2	2.432,00
	3	2.474,00
	4	2.691,00
	5,5	2.794,00
KDN 40-160 2.900 R.P.M.	7,5	3.022,00
	10	3.188,00
	4	2.761,00
	5,5	2.862,00
	7,5	3.093,00
KDN 40-200 2.900 R.P.M.	10	3.258,00
	15	3.829,00
	20	3.939,00
	5,5	2.927,00
	7,5	3.156,00
KDN 40-250 2.900 R.P.M.	10	3.323,00
	15	3.893,00
	20	4.003,00
	25	4.466,00
	15	4.029,00
KDN 50-125 2.900 R.P.M.	20	4.138,00
	25	4.601,00
	30	5.211,00
	40	5.972,00
	4	2.768,00
KDN 50-160 2.900 R.P.M.	5,5	2.868,00
	7,5	3.099,00
	10	3.265,00
	15	3.836,00
	5,5	2.916,00
KDN 50-200 2.900 R.P.M.	7,5	3.145,00
	10	3.311,00
	15	3.882,00
	20	3.992,00
	25	4.455,00
KDN 50-250 2.900 R.P.M.	10	3.362,00
	15	3.933,00
	20	4.043,00
	25	4.506,00
	30	5.115,00
KDN 50-250 2.900 R.P.M.	40	5.877,00
	20	4.181,00
	25	4.646,00
	30	5.256,00
	40	6.017,00
KDN 50-250 2.900 R.P.M.	50	6.232,00
	60	6.979,00

	TIPO TYPE	CV HP	PVP € Motor IE-3
--	--------------	----------	---------------------

KDN - COMPLETA CON MOTOR SOBRE BANCADA A 2.900 R.P.M.

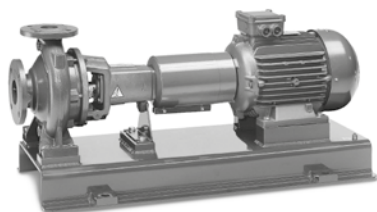

2.900 R.P.M.

KDN 65-125 2.900 R.P.M.	5,5	2.932,00
	7,5	3.162,00
	10	3.328,00
	15	3.898,00
	20	4.007,00
KDN 65-160 2.900 R.P.M.	7,5	3.186,00
	10	3.354,00
	15	3.924,00
	20	4.034,00
	25	4.496,00
KDN 65-200 2.900 R.P.M.	30	5.106,00
	15	4.048,00
	20	4.157,00
	25	4.621,00
	30	5.231,00
KDN 65-250 2.900 R.P.M.	40	5.992,00
	50	6.207,00
	30	5.746,00
	40	6.507,00
	50	6.722,00
KDN 65-315 2.900 R.P.M.	60	7.470,00
	75	8.917,00
	40	6.964,00
	50	7.180,00
	60	7.927,00
KDN 80-160 2.900 R.P.M.	75	9.375,00
	100	10.906,00
	125	11.335,00
	150	15.238,00
	10	3.505,00
KDN 80-200 2.900 R.P.M.	15	4.075,00
	20	4.186,00
	25	4.648,00
	30	5.258,00
	40	6.019,00
KDN 80-250 2.900 R.P.M.	50	6.235,00
	25	4.954,00
	30	5.563,00
	40	6.325,00
	50	6.541,00
KDN 80-315 2.900 R.P.M.	60	7.287,00
	75	8.736,00
	100	9.462,00
	50	7.019,00
	60	7.765,00
KDN 80-315 2.900 R.P.M.	75	9.213,00
	100	9.961,00
	125	10.390,00
	75	9.375,00
	100	10.906,00
KDN 80-315 2.900 R.P.M.	125	11.335,00
	150	15.238,00

	TIPO TYPE	CV HP	PVP € Motor IE-3
--	--------------	----------	---------------------

**KDN - COMPLETA CON MOTOR SOBRE BANCADA
A 2,900 R.P.M.**

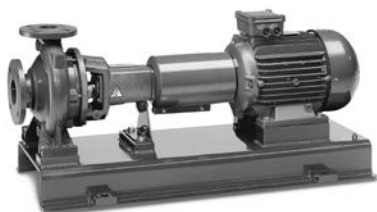

2.900 R.P.M.

KDN 100-200 2.900 R.P.M.	40	6.668,00
	50	6.883,00
	60	7.630,00
	75	9.077,00
	100	9.819,00
KDN 100-250 2.900 R.P.M.	125	10.248,00
	60	7.939,00
	75	9.386,00
	100	10.142,00
	125	10.571,00
	150	14.474,00

**KDN - COMPLETA CON MOTOR SOBRE BANCADA
A 1,450 R.P.M.**

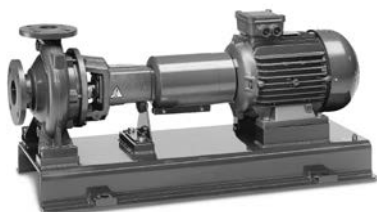

1.450 R.P.M.

KDN 32-125 1 1.450 R.P.M.	0,5	2.140,00
	0,75	2.224,00
KDN 32-125 1.450 R.P.M.	0,5	2.151,00
	0,75	2.235,00
KDN 32-160 1 1.450 R.P.M.	1	2.318,00
	0,5	2.211,00
	0,75	2.295,00
KDN 32-160 1.450 R.P.M.	1	2.376,00
	0,5	2.223,00
	0,75	2.307,00
KDN 32-200 1 1.450 R.P.M.	1	2.388,00
	1,5	2.435,00
	0,5	2.310,00
KDN 32-200 1.450 R.P.M.	0,75	2.393,00
	1	2.472,00
	1,5	2.520,00
KDN 40-125 1.450 R.P.M.	0,5	2.320,00
	0,75	2.403,00
	1	2.482,00
	1,5	2.529,00
	2	2.556,00
KDN 40-160 1.450 R.P.M.	3	2.739,00
	0,5	2.240,00
	0,75	2.323,00
KDN 40-200 1.450 R.P.M.	1	2.403,00
	1,5	2.451,00
	0,5	2.311,00
KDN 40-200 1.450 R.P.M.	0,75	2.394,00
	1	2.473,00
	1,5	2.521,00
	2	2.548,00
	0,75	2.463,00
KDN 40-200 1.450 R.P.M.	1	2.537,00
	1,5	2.585,00
	2	2.612,00
	3	2.796,00
	4	2.848,00

	TIPO TYPE	CV HP	PVP € Motor IE-3
--	--------------	----------	---------------------

KDN - COMPLETA CON MOTOR SOBRE BANCADA A 1,450 R.P.M.

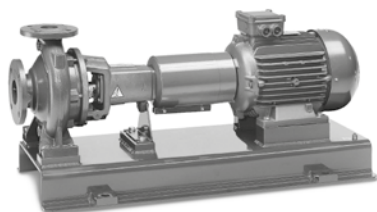

1.450 R.P.M.

KDN 40-250 1.450 R.P.M.	2	2.747,00
	3	2.931,00
	4	2.983,00
	5,5	3.107,00
	0,5	2.318,00
KDN 50-125 1.450 R.P.M.	0,75	2.402,00
	1	2.481,00
	1,5	2.528,00
	2	2.555,00
	1	2.526,00
KDN 50-160 1.450 R.P.M.	1,5	2.573,00
	2	2.601,00
	3	2.784,00
	4	2.836,00
	1	2.577,00
KDN 50-200 1.450 R.P.M.	1,5	2.626,00
	2	2.652,00
	3	2.836,00
	4	2.888,00
	5,5	3.011,00
KDN 50-250 1.450 R.P.M.	3	2.974,00
	4	3.027,00
	5,5	3.151,00
	7,5	3.334,00
KDN 65-125 1.450 R.P.M.	1	2.541,00
	1,5	2.591,00
	2	2.617,00
	3	2.800,00
KDN 65-160 1.450 R.P.M.	1	2.568,00
	1,5	2.616,00
	2	2.643,00
	3	2.826,00
KDN 65-200 1.450 R.P.M.	4	2.879,00
	1,5	2.740,00
	2	2.768,00
	3	2.950,00
KDN 65-250 1.450 R.P.M.	4	3.003,00
	5,5	3.127,00
	7,5	3.310,00
	4	3.517,00
	5,5	3.642,00
KDN 65-315 1.450 R.P.M.	7,5	3.826,00
	10	3.972,00
	15	4.627,00
	7,5	4.356,00
	10	4.462,00
	15	5.086,00
	20	5.225,00
	25	6.083,00

	TIPO TYPE	CV HP	PVP € Motor IE-3
--	--------------	----------	---------------------

**KDN - COMPLETA CON MOTOR SOBRE BANCADA
A 1,450 R.P.M.**



1.450 R.P.M.

KDN 80-160 1.450 R.P.M.	1,5	2.767,00
	2	2.795,00
KDN 80-200 1.450 R.P.M.	3	2.977,00
	4	3.029,00
	5,5	3.153,00
	7,5	3.336,00
	2	3.101,00
	3	3.284,00
	4	3.335,00
KDN 80-250 1.450 R.P.M.	5,5	3.461,00
	7,5	3.643,00
	10	3.791,00
	15	4.446,00
	5,5	3.938,00
	7,5	4.120,00
KDN 80-315 1.450 R.P.M.	10	4.269,00
	15	4.924,00
	20	5.064,00
	10	4.637,00
	15	5.291,00
KDN 100-200 1.450 R.P.M.	20	5.431,00
	25	6.288,00
	30	6.491,00
	40	7.083,00
	4	3.679,00
	5,5	3.802,00
KDN 100-250 1.450 R.P.M.	7,5	3.986,00
	10	4.135,00
	15	4.788,00
	20	4.929,00
	7,5	4.295,00
	10	4.442,00
KDN 100-315 1.450 R.P.M.	15	5.097,00
	20	5.237,00
	25	6.094,00
	15	5.554,00
	20	5.700,00
KDN 125-250 1.450 R.P.M.	25	6.551,00
	30	6.754,00
	40	7.346,00
	50	8.195,00
	10	4.834,00
	15	5.488,00
KDN 150-200 1.450 R.P.M.	20	5.736,00
	25	6.578,00
	30	6.689,00
	40	7.281,00
	7,5	5.686,00
	10	5.835,00
	15	6.458,00
	20	6.783,00

	TIPO TYPE	CV HP	PVP € Motor IE-3
--	--------------	----------	---------------------

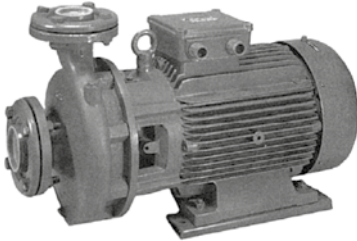
HK

HK 10 M	1	377,00
HK 10 T	1	394,00
HK 25 M	2,5	699,00
HK 25 T	2,5	681,00
HK 40 T	4	1.016,00
HK 55 T	5,5	1.135,00
HK 75 T	7,5	2.457,00
HK 100 T	10	2.611,00
HK 101 T	10	2.658,00
HK 102 T	10	3.162,00
HK 125 T	12,5	3.245,00
HK 126 T	12,5	3.344,00
HK 150 T	15	3.369,00
HK 151 T	15	3.466,00

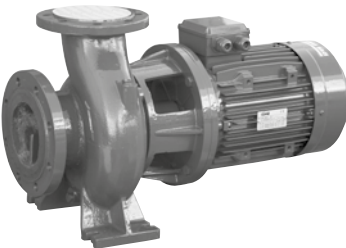
CR

CR 300	3	1.009,00
CR 400	4	1.151,00
CR 550	5,5	1.470,00
CR 551	5,5	1.474,00
CR 750	7,5	1.730,00
CR 1000	10	2.160,00
CR 1250	12,5	2.434,00
CR 1500	15	2.584,00

* Estas bombas no equipan contrabridas de serie.

* Counterflanges are not equipped as standard.

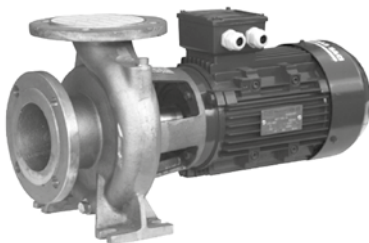
CRB - BRONCE MARINO

CRB 300	3	CONSULTAR
CRB 400	4	CONSULTAR
CRB 550	5,5	CONSULTAR
CRB 551	5,5	CONSULTAR
CRB 750	7,5	CONSULTAR
CRB 1000	10	CONSULTAR
CRB 1250	12,5	CONSULTAR
CRB 1500	15	CONSULTAR

* Estas bombas no equipan contrabridas de serie.

* Counterflanges are not equipped as standard.

	TIPO TYPE	CV HP	PVP € Monof/ Single ph	PVP € Trif/ Three ph
--	--------------	----------	---------------------------	-------------------------



V-NOX

V-NOX 303	1,25	533,00	488,00
V-NOX 304	1,5	549,00	520,00
V-NOX 305	2	574,00	542,00
V-NOX 306	3	-	582,00
V-NOX 307	3	-	647,00
V-NOX 308	4	-	764,00
V-NOX 309	4	-	794,00
V-NOX 310	5,5	-	844,00
V-NOX 403	2	569,00	532,00
V-NOX 404	3	-	586,00
V-NOX 405	4	-	764,00
V-NOX 406	4	-	802,00
V-NOX 407	5,5	-	878,00



[e]NOX - BOMBA CON VARIADOR DE FRECUENCIA Y MOTOR DE IMANES PERMANENTES

[e]NOX 306 M	3	1.446,00	-
[e]NOX 310 T	5,5	-	1.716,00
[e]NOX 407 T	5,5	-	1.701,00

	TIPO TYPE	CV HP	PVP € Motor IE-3
--	--------------	----------	---------------------

VAT



VAT 127L-6	3	1.031,00
VAT 127L-7	3	1.067,00
VAT 127L-8	3	1.098,00
VAT 127L-9	4	1.204,00
VAT 127L-10	4	1.234,00
VAT 127L-11	5,5	1.334,00
VAT 127L-12	5,5	1.363,00
VAT 127L-13	5,5	1.393,00
VAT 163L-3	4	1.505,00
VAT 163L-4	5,5	1.633,00
VAT 163L-5	7,5	1.898,00
VAT 163L-6	7,5	1.958,00
VAT 163L-7	10	2.171,00
VAT 163L-8	10	2.232,00
VAT 163L-9	12,5	2.580,00
VAT 205-3	12,5	3.200,00
VAT 205-4	20	3.604,00
VAT 205-5	20	3.818,00
VAT 205-6	25	4.212,00

	TIPO TYPE	CV HP	PVP € Motor IE-3
--	--------------	----------	---------------------

XV-F - AISI 304



Sello mecánico
Mechanical seal

XV-F 5-8	1,5	766,00
XV-F 5-8 Monofásica	1,5	814,00
XV-F 5-10	2	862,00
XV-F 5-10 Monofásica	2	953,00
XV-F 5-14	3	1.017,00
XV-F 5-16	3	1.065,00
XV-F 5-20	4	1.333,00
XV-F 5-29	5,5	1.661,00
XV-F 5-36	7,5	2.119,00
XV-F 10-6	3	1.045,00
XV-F 10-9	4	1.357,00
XV-F 10-10	5,5	1.490,00
XV-F 10-12	5,5	1.579,00
XV-F 10-16	7,5	2.086,00
XV-F 10-22	10	2.537,00
XV-F 15-5	5,5	1.422,00
XV-F 15-7	7,5	1.893,00
XV-F 15-9	10	2.220,00
XV-F 15-14	15	3.097,00
XV-F 15-17	20	3.401,00
XV-F 20-5	7,5	1.841,00
XV-F 20-7	10	2.200,00
XV-F 20-10	15	2.965,00
XV-F 20-14	20	3.376,00
XV-F 20-17	25	3.834,00
XV-F 32-3	7,5	2.334,00
XV-F 32-4	10	2.698,00
XV-F 32-6	15	3.627,00
XV-F 32-8	20	4.137,00
XV-F 32-10	25	4.707,00
XV-F 32-12	30	5.548,00
XV-F 32-14	40	6.899,00
XV-F 45-2	10	2.570,00
XV-F 45-3	15	3.474,00
XV-F 45-4	20	3.786,00
XV-F 45-5	25	4.237,00
XV-F 45-6	30	4.964,00
XV-F 45-9-2	40	6.731,00
XV-F 45-10	50	7.201,00
XV-F 45-13-2	60	8.542,00
XV-F 64-2	15	3.331,00
XV-F 64-3-1	20	3.773,00
XV-F 64-4-2	25	4.254,00
XV-F 64-4	30	4.795,00
XV-F 64-6-2	40	6.334,00
XV-F 64-7-1	50	6.834,00
XV-F 64-8-1	60	7.866,00
XV-F 90-2-2	15	3.520,00
XV-F 90-2	20	3.757,00
XV-F 90-3-2	25	4.275,00
XV-F 90-3	30	4.943,00
XV-F 90-4	40	6.324,00
XV-F 90-5	50	6.944,00
XV-F 90-6	60	7.971,00

* Estas bombas no equipan contrabridas de serie. Precios de las contrabridas en la página siguiente.

* Counterflanges are not equipped as standard. See the prices on next page.

	TIPO TYPE	CV HP	PVP € Motor IE-3
--	--------------	----------	---------------------

XV-F - AISI 304



* Estas bombas no equipan contrabridas de serie.
* Counterflanges are not equipped as standard.

XV-F 120-1	15	6.467,00
XV-F 120-2-1	25	8.109,00
XV-F 120-2	30	8.616,00
XV-F 120-3	40	10.991,00
XV-F 120-4-1	50	12.228,00
XV-F 120-5-1	60	13.864,00
XV-F 120-6-1	75	17.458,00
XV-F 120-7	100	19.076,00
XV-F 150-1-1	15	6.497,00
XV-F 150-1	20	6.820,00
XV-F 150-2-1	30	8.537,00
XV-F 150-3-2	40	11.100,00
XV-F 150-3	50	11.382,00
XV-F 150-4-1	60	13.073,00
XV-F 150-5-2	75	16.699,00
XV-F 150-6	100	18.422,00

XV-F - KITS CONTRABRIDAS PARA BOMBAS



* Bridas de Hierro
* Iron Flanges

KIT BRIDAS XV-F DN 32 (PN 10) (ROSCADA)	103,00
KIT BRIDAS XV-F DN 32 (PN 16) (PLANA SOLD)	51,00
KIT BRIDAS XV-F DN 32 (PN 40) (CUELLO SOLD)	105,00
KIT BRIDAS XV-F DN 40 (PN 10) (ROSCADA)	114,00
KIT BRIDAS XV-F DN 40 (PN 16) (PLANA SOLD)	56,00
KIT BRIDAS XV-F DN 40 (PN 40) (CUELLO SOLD)	126,00
KIT BRIDAS XV-F DN 50 (PN 10) (ROSCADA)	148,00
KIT BRIDAS XV-F DN 50 (PN 16) (PLANA SOLD)	68,00
KIT BRIDAS XV-F DN 50 (PN 40) (CUELLO SOLD)	142,00
KIT BRIDAS XV-F DN 65 (PN 10) (ROSCADA)	175,00
KIT BRIDAS XV-F DN 65 (PN 16) (PLANA SOLD)	78,00
KIT BRIDAS XV-F DN 65 (PN 40) (CUELLO SOLD)	167,00
KIT BRIDAS XV-F DN 80 (PN 16) (PLANA SOLD)	101,00
KIT BRIDAS XV-F DN 80 (PN 40) (CUELLO SOLD)	215,00
KIT BRIDAS XV-F DN 100 (PN 16) (PLANA SOLD)	108,00
KIT BRIDAS XV-F DN 100 (PN 40) (CUELLO SOLD)	296,00
KIT BRIDAS XV-F DN 125 (PN 16) (PLANA SOLD)	133,00
KIT BRIDAS XV-F DN 125 (PN 40) (CUELLO SOLD)	417,00

	TIPO TYPE	CV HP	PVP € Motor IE-3
--	--------------	----------	---------------------

XVN-F - AISI 316



XVN-F 1/7	0,5	983,00
XVN-F 1/11	0,75	1.094,00
XVN-F 1/15	1	1.278,00
XVN-F 1/22	1,5	1.426,00
XVN-F 1/30	2	1.713,00
XVN-F 1/40	3	1.993,00
XVN-F 3/6	0,75	994,00
XVN-F 3/8	1	1.149,00
XVN-F 3/12	1,5	1.259,00
XVN-F 3/16	2	1.527,00
XVN-F 3/23	3	1.687,00
XVN-F 3/31	4	2.035,00
XVN-F 5/8	1,5	1.195,00
XVN-F 5/11	2	1.383,00
XVN-F 5/16	3	1.562,00
XVN-F 5/21	4	1.850,00
XVN-F 5/28	5,5	2.215,00
XVN-F 5/33	7,5	2.864,00
XVN-F 10/6	3	1.724,00
XVN-F 10/8	4	1.964,00
XVN-F 10/11	5,5	2.342,00
XVN-F 10/15	7,5	3.152,00
XVN-F 10/21	10	3.429,00
XVN-F 10/22	15	4.301,00
XVN-F 15/3	4	1.749,00
XVN-F 15/5	5,5	2.085,00
XVN-F 15/7	7,5	2.754,00
XVN-F 15/9	10	2.956,00
XVN-F 15/14	15	4.103,00
XVN-F 15/18	20	4.566,00
XVN-F 20/5	7,5	2.746,00
XVN-F 20/7	10	2.932,00
XVN-F 20/10	15	4.016,00
XVN-F 20/14	20	4.589,00
XVN-F 20/17	25	4.982,00
XVN-F 32/3	7,5	3.604,00
XVN-F 32/4	10	3.858,00
XVN-F 32/6	15	4.505,00
XVN-F 32/8	20	5.345,00
XVN-F 32/10	25	6.144,00
XVN-F 32/12	30	7.482,00
XVN-F 32/16	40	10.554,00

* No equipan contrabridas de serie (consultar precio).

* Counterflanges not included (request prices).

	TIPO TYPE	CV HP	PVP € BOMBA/Pump
--	--------------	----------	---------------------

SIGMA



SIGMA 102 M	0,33	257,00
SIGMA 103 M	0,5	274,00
SIGMA 104 M	0,75	287,00
SIGMA 105 M	1	312,00
SIGMA 105 T	1	317,00



SIGMA 202 M	1	349,00
SIGMA 203 M	1	352,00
SIGMA 204 M	1,25	385,00
SIGMA 205 M	1,5	454,00
SIGMA 205 T	1,5	454,00



SIGMA 303 M	1,25	503,00
SIGMA 303 T	1,25	501,00
SIGMA 304 M	1,5	546,00
SIGMA 304 T	1,5	523,00
SIGMA 305 M	2	612,00
SIGMA 305 T	2	573,00
SIGMA 306 T	3	626,00
SIGMA 307 T	3	654,00

SIGMA 403 M	2	546,00
SIGMA 403 T	2	518,00
SIGMA 404 T	3	584,00

SIGMA + SACIPRESS



SIGMA 103 M/ SACIPRESS	0,5	339,00
SIGMA 104 M/ SACIPRESS	0,75	352,00
SIGMA 105 M/ SACIPRESS	1	377,00
SIGMA 105 T/ SACIPRESS	1	382,00

SIGMA 203 M/ SACIPRESS	1	417,00
SIGMA 204 M/ SACIPRESS	1,25	450,00
SIGMA 205 M/ SACIPRESS	1,5	519,00
SIGMA 205 T/ SACIPRESS	1,5	519,00

PE - PERIFERICAS



PE 38 M	0,5	164,00
PE 60 M	0,8	198,00
PE 60 T	0,8	198,00

	TIPO TYPE	CV HP	PVP € BOMBA/Pump
--	--------------	----------	---------------------



JET

JET 82 M	0,8	236,00
JET 82 T	0,8	230,00
JET 102 M	1	277,00
JET 102 T	1	291,00
JET 15 M	1,5	622,00
JET 15 T	1,5	615,00
JET 20 M	2	620,00
JET 25 M	2,5	710,00
JET 25 T	2,5	697,00

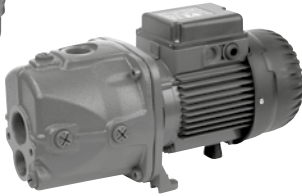

AP - ASPIRACIÓN PROFUNDA

AP 10.2 M	1	414,00
AP 10.2 T	1	435,00
AP 15 M	1,5	647,00
AP 15 T	1,5	638,00
AP 25 M	2,5	737,00
AP 25 T	2,5	720,00

NOVA-FEKA-MINI DRX - SUMERGIBLES ACHIQUE

NOVABOX 300 M	0,3	643,00
NOVA SALT M AUT	0,3	281,00
NOVA 180 M	0,3	151,00
NOVA 180 M AUT	0,3	158,00
NOVA 200 M	0,3	194,00
NOVA 300 M AUT	0,3	192,00
NOVA 600 M	0,75	312,00
NOVA 600 M AUT	0,75	291,00
NOVA 600 T	0,75	284,00
FEKA 600 M	0,75	284,00
FEKA 600 M AUT	0,75	276,00
FEKA 600 T	0,75	279,00
MINI DRX M	0,33	220,00
MINI DRX M AUT	0,33	236,00
DISPOSITIVO ASPIRACIÓN MINI DRX (3mm)		9,00



SUMERGIBLES PARA FUENTES DECORATIVAS Y ACUARIOS

PUMP 400	22,00
PUMP 1150	32,00
PUMP 700	47,00
PUMP 1200	68,00
PUMP 2800	105,00





TIPO
TYPE

PVP €



A. CAÑON RIVA PLANO 306,00

B. CAÑON RIVA REDONDO 313,00

C. CASCADA RIMINI 1.650,00

D. CASCADA ALDARA + ANCLAJE 1.880,00

E. CASCADA ALDARA MINI 1.000,00

F. CAÑON DOLCE 350 SATINADO 1.648,00

G. PULSADOR PIEZOELECTRICO AISI316 + CABLE 136,00



C

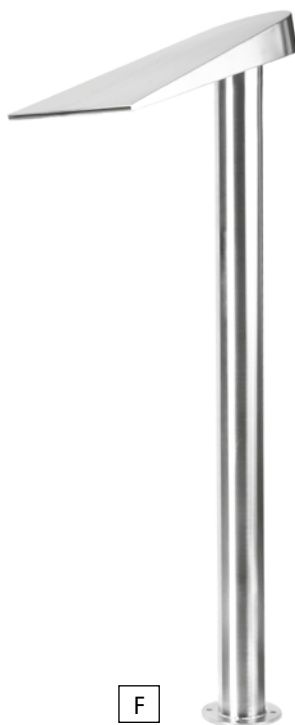

F



E



D



G





H



I



J

H. INTERCAMBIADOR CALOR SS-45 (20KW)	510,00
H. INTERCAMBIADOR CALOR SS-70 (40KW)	556,00
H. INTERCAMBIADOR CALOR SS-130 (60KW)	575,00
H. INTERCAMBIADOR CALOR SS-180 (80KW)	805,00
H. INTERCAMBIADOR CALOR SS-250 (120KW)	832,00
H. INTERCAMBIADOR CALOR SS-300 (160KW)	988,00
H. INTERCAMBIADOR CALOR SS-500 (200KW)	1.304,00
H. INTERCAMBIADOR CALOR SS-1000 (340KW)	2.115,00
I. INTERCAMBIADOR CALOR TITANIO TI-250 (20-80KW)	1.470,00
I. INTERCAMBIADOR CALOR TITANIO TI-350 (120-160KW)	1.654,00
I. INTERCAMBIADOR CALOR TITANIO TI-500 (200KW)	1.960,00
I. INTERCAMBIADOR CALOR TITANIO TI-750	2.503,00
I. INTERCAMBIADOR CALOR TITANIO TI-1000	3.014,00
J. FRONTAL SIMPLE 316L PREPARADO PARA PIEZ.	1.112,00
J. FRONTAL SIMPLE 316L PREPARADO PARA PNEU.	1.084,00
J. FRONTAL COMPLETO 316L PREPARADO PARA PIEZ.	1.636,00
J. FRONTAL COMPLETO 316L PREPARADO PARA PNEU.	1.636,00

TIPO TYPE	CV HP	PVP € Bomba/Pump Optima	PVP € con cuadro/with panel Smart Optima
--------------	----------	-------------------------------	--

OPTIMA - AUTOASPIRANTES PARA PISCINAS



OPTIMA 25 M	0,25	287,00	506,00
OPTIMA 25 T	0,25	287,00	-
OPTIMA 33 M	0,33	287,00	506,00
OPTIMA 33 T	0,33	287,00	-
OPTIMA 50 M	0,5	305,00	524,00
OPTIMA 50 T	0,5	305,00	-
OPTIMA 75 M	0,75	314,00	533,00
OPTIMA 75 T	0,75	314,00	-
OPTIMA 100 M	1	347,00	566,00
OPTIMA 100 T	1	347,00	-
OPTIMA 150 M	1,5	399,00	618,00
OPTIMA 150 T	1,5	399,00	-

KIT SOPORTE PARED SMART POOL

22,00

TIPO TYPE	CV HP	PVP € Bomba/Pump Winner	PVP € con cuadro/with panel Smart Winner	PVP € con variador with inverter VSD Winner
--------------	----------	-------------------------------	--	--

WINNER - AUTOASPIRANTES PARA PISCINAS



WINNER 50 M	0,5	340,00	559,00	1.099,00
WINNER 50 T	0,5	340,00	-	-
WINNER 75 M	0,75	363,00	582,00	1.122,00
WINNER 75 T	0,75	363,00	-	-
WINNER 100 M	1	402,00	621,00	1.161,00
WINNER 100 T	1	402,00	-	-
WINNER 150 M	1,5	438,00	657,00	1.197,00
WINNER 150 T	1,5	438,00	-	-
WINNER 200 M	2	514,00	733,00	1.273,00
WINNER 200 T	2	514,00	-	-
WINNER 300 M	3	604,00	823,00	1.312,00
WINNER 300 T	3	553,00	-	-

KIT SOPORTE PARED SMART POOL

22,00

KIT SOPORTE PARED [e]JOY

79,00

* Las bombas VSD WINNER incorporan el variador [e]JOY MT2

* The VSD WINNER pumps includes the [e]JOY MT2 inverter

TIPO TYPE	CV HP	PVP €
--------------	----------	-------



CUADRO ELÉCTRICO PARA BOMBAS DE PISCINA

SMART POOL COMPLETO (PARED / WALL)		230,00
CUADRO (PANEL) FOCOS LED 50W		90,00
CUADRO (PANEL) FOCOS LED 2x50W		160,00
SONDA (PROBE) TEMPERATURA PT-100 1/4" AISI 316		67,00

	TIPO TYPE	CV HP	PVP €
--	--------------	----------	-------



[e]WINNER - VELOCIDAD VARIABLE CON MOTOR DE IMANES PERMANENTES

[e]WINNER 300 M IE5	MAX 3 HP	1.615,00
SOPORTE PARED VARIADOR		79,00



SUPRA - AUTOASPIRANTES PARA PISCINAS

SUPRA 300 - 2900 RPM	3	885,00
SUPRA 400 - 2900 RPM	4	942,00
SUPRA 550 - 2900 RPM	5,5	1.116,00



BRAVUS - CENTRIFUGAS CONTRA CORRIENTE

BRAVUS 300 - 2900 RPM	3	809,00
BRAVUS 400 - 2900 RPM	4	863,00
BRAVUS 550 - 2900 RPM	5,5	1.038,00

	TIPO TYPE	CV HP	PVP € Bomba/Pump Magnus	PVP € con variador with inverter VSD Magnus
--	--------------	----------	-------------------------------	--



MAGNUS - AUTOASPIRANTES PARA PISCINAS

MAGNUS-4 250	2,5	1.163,00	1.958,00
MAGNUS-4 300	3	1.163,00	1.958,00
MAGNUS-4 400	4	1.191,00	1.986,00
MAGNUS-4 550	5,5	1.330,00	2.125,00
MAGNUS-4 550 (Rod. BRONCE)	5,5	1.700,00	2.495,00
MAGNUS-4 750	7,5	1.801,00	3.391,00
MAGNUS-4 750 (Rod. BRONCE)	7,5	2.137,00	3.727,00
MAGNUS-4 1000	10	1.853,00	3.443,00
MAGNUS-4 1000 (Rod. BRONCE)	10	2.177,00	3.767,00
MAGNUS-2 1250	12,5	2.203,00	3.793,00
MAGNUS-2 1500	15	2.230,00	3.820,00

BOMBAS A 1.450RPM EXCEPTO
MODELOS DE 12,5CV Y 15CV
PUMPS AT 1,450RPM EXCEPT
THE 12,5HP AND 15HP TYPES

KIT CONTRABRIDAS PVC DN-110

114,00

* Las bombas VSD MAGNUS incorporan el variador [e]POOL TT3

* The VSD MAGNUS pumps includes the [e]POOL TT3 inverter

	TIPO TYPE	CV HP	PVP € Bomba Pump
--	--------------	----------	------------------------



[e]MAGNUS BOMBA PISCINA VELOCIDAD VARIABLE CON MOTOR DE IMANES PERMANENTES

[e]MAGNUS-4 550 IE5	5,5	2.934,00
[e]MAGNUS-4 550 (ROD. BRONCE) IE5	5,5	3.357,00
SOPORTE PARED VARIADOR		79,00

	TIPO TYPE	CV HP	PVP € Bomba Pump
--	--------------	----------	------------------------

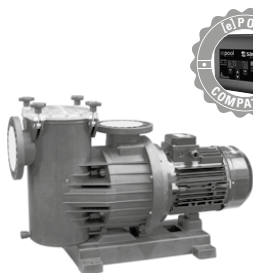

HF-2 MAGNUS - ALTA PRESIÓN 2.850 RPM

HF-2 MAGNUS-4 558	5,5	CONSULTAR
HF-2 MAGNUS-4 558 (ROD. BRONCE)	5,5	CONSULTAR
HF-2 MAGNUS-4 758	7,5	CONSULTAR
HF-2 MAGNUS-4 758 (ROD. BRONCE)	7,5	CONSULTAR
HF-2 MAGNUS-4 1008	10	1.912,00
HF-2 MAGNUS-4 1008 (ROD. BRONCE)	10	CONSULTAR
KIT CONTRABRIDAS PVC DN-110		114,00



VERT MAGNUS AUTOASPIRANTES VERTICALES PISCINAS

VERT MAGNUS-4 250	2,5	4.163,00
VERT MAGNUS-4 300	3	4.163,00
VERT MAGNUS-4 400	4	4.203,00
VERT MAGNUS-4 550	5,5	4.365,00
VERT MAGNUS-4 550 (ROD. BRONCE)	5,5	4.752,00
VERT MAGNUS-4 750	7,5	4.555,00
VERT MAGNUS-4 750 (ROD. BRONCE)	7,5	4.945,00
VERT MAGNUS-4 1000	10	4.739,00
VERT MAGNUS-4 1000 (ROD. BRONCE)	10	5.137,00
VERT MAGNUS-2 1250	12,5	5.220,00
VERT MAGNUS-2 1500	15	5.265,00

	TIPO TYPE	CV HP	PVP € Bomba/Pump Kontra	PVP € con variador with inverter VSD Kontra
--	--------------	----------	-------------------------------	--



KONTRA - CENTRIFUGAS DE GRAN CAUDAL (CONTRACORRIENTE)

KONTRA-4 250	2,5	978,00	1.773,00
KONTRA-4 300	3	978,00	1.773,00
KONTRA-4 400	4	1.004,00	1.799,00
KONTRA-4 550	5,5	1.147,00	1.942,00
KONTRA-4 550 (ROD. BRONCE)	5,5	1.516,00	2.311,00
KONTRA-4 750	7,5	1.608,00	3.198,00
KONTRA-4 750 (ROD. BRONCE)	7,5	1.943,00	3.533,00
KONTRA-4 1000	10	1.653,00	3.243,00
KONTRA-4 1000 (ROD. BRONCE)	10	1.978,00	3.568,00
KONTRA-2 1250	12,5	2.004,00	3.594,00
KONTRA-2 1500	15	2.030,00	3.620,00
KIT CONTRABRIDAS PVC DN-110		114,00	

BOMBAS A 1.450RPM EXCEPTO
MODELOS DE 12,5CV Y 15CV
PUMPS AT 1,450RPM EXCEPT
THE 12,5HP AND 15HP TYPES

* Las bombas VSD KONTRA incorporan el variador [e]POOL TT3
* The VSD KONTRA pumps includes the [e]POOL TT3 inverter

	TIPO TYPE	PVP €
--	--------------	-------



VARIADORES DE FRECUENCIA PARA BOMBAS DE PISCINA

VARIADOR DE VELOCIDAD [e]JOY (MT2)	640,00
VARIADOR DE VELOCIDAD [e]POOL (TT3-11)	832,00
VARIADOR DE VELOCIDAD [e]POOL (TT3-30)	1.650,00
SONDA TEMPERATURA NTC 47K B=4000 1/4" AISI 316	74,00
SOPORTE PARED VARIADOR [e]JOY - [e]POOL	79,00

	TIPO TYPE	CV HP	PVP € Motor IE-3
--	--------------	----------	---------------------



2.900 r.p.m.

CF-2 - 2,900 RPM

CF-2 300 (2.900 r.p.m.)	3	1.582,00
CF-2 400 (2.900 r.p.m.)	4	1.724,00
CF-2 550 (2.900 r.p.m.)	5,5	2.057,00
CF-2 551 (2.900 r.p.m.)	5,5	2.061,00
CF-2 750 (2.900 r.p.m.)	7,5	2.315,00
CF-2 1000 (2.900 r.p.m.)	10	2.639,00
CF-2 1250 (2.900 r.p.m.)	12,5	2.971,00
CF-2 1500 (2.900 r.p.m.)	15	3.120,00



2.900 r.p.m.

HF-2 GRAN ALTURA A 2,900 RPM

HF-2 308 (2.900 r.p.m.)	3	2.269,00
HF-2 408 (2.900 r.p.m.)	4	2.426,00
HF-2 558 (2.900 r.p.m.)	5,5	2.515,00
HF-2 758 (2.900 r.p.m.)	7,5	3.061,00
HF-2 1008 (2.900 r.p.m.)	10	3.376,00
HF-2 1208 (2.900 r.p.m.)	10	3.346,00
HF-2 1508 (2.900 r.p.m.)	15	4.008,00
HF-2 2008 (2.900 r.p.m.)	20	4.253,00
HF-2 2508 (2.900 r.p.m.)	25	4.483,00



2.900 r.p.m.

VERT CF-2 VERTICAL A 2,900 RPM

VERT CF-2 300 (2.900 r.p.m.)	3	2.622,00
VERT CF-2 400 (2.900 r.p.m.)	4	2.700,00
VERT CF-2 550 (2.900 r.p.m.)	5,5	2.998,00
VERT CF-2 551 (2.900 r.p.m.)	5,5	3.005,00
VERT CF-2 750 (2.900 r.p.m.)	7,5	3.287,00
VERT CF-2 1000 (2.900 r.p.m.)	10	3.571,00
VERT CF-2 1250 (2.900 r.p.m.)	12,5	3.799,00
VERT CF-2 1500 (2.900 r.p.m.)	15	3.948,00



2.900 r.p.m.

VERT HF-2 VERTICALES PARA GRAN ALTURA A 2,900 RPM

VERT HF-2 308 (2.900 r.p.m.)	3	3.047,00
VERT HF-2 408 (2.900 r.p.m.)	4	3.205,00
VERT HF-2 558 (2.900 r.p.m.)	5,5	3.293,00
VERT HF-2 758 (2.900 r.p.m.)	7,5	3.839,00
VERT HF-2 1008 (2.900 r.p.m.)	10	4.154,00
VERT HF-2 1208 (2.900 r.p.m.)	10	4.125,00
VERT HF-2 1508 (2.900 r.p.m.)	15	4.789,00
VERT HF-2 2008 (2.900 r.p.m.)	20	5.021,00
VERT HF-2 2508 (2.900 r.p.m.)	25	5.251,00

**NO EQUIPAN CONTRABRIDAS / COUNTERFLANGES NOT INCLUDED
COMPATIBLE CON VARIADOR [E]POOL / VSD [E]POOL COMPATIBLE**

	TIPO TYPE	CV HP	PVP € Motor IE-3
--	--------------	----------	---------------------



1.450 r.p.m.

CF-4 CON PREFILTRO A 1,450 RPM

CF-4 300	(1.450 r.p.m.)	3	2.476,00
CF-4 400	(1.450 r.p.m.)	4	2.771,00
CF-4 550	(1.450 r.p.m.)	5,5	2.902,00
CF-4 552	(1.450 r.p.m.)	5,5	3.220,00
CF-4 750	(1.450 r.p.m.)	7,5	3.458,00
CF-4 1000	(1.450 r.p.m.)	10	3.956,00
CF-4 1500	(1.450 r.p.m.)	15	5.166,00
CF-4 2000	(1.450 r.p.m.)	20	5.980,00
CF-4 2500	(1.450 r.p.m.)	25	6.525,00



1.450 r.p.m.

HF-4 CON PREFILTRO GRAN ALTURA A 1,450 RPM

HF-4 308	(1.450 r.p.m.)	3	2.879,00
HF-4 408	(1.450 r.p.m.)	4	2.913,00
HF-4 558	(1.450 r.p.m.)	5,5	3.131,00
HF-4 758	(1.450 r.p.m.)	7,5	3.934,00
HF-4 1008	(1.450 r.p.m.)	10	4.548,00
HF-4 1508	(1.450 r.p.m.)	15	5.378,00
HF-4 2008	(1.450 r.p.m.)	20	5.694,00
HF-4 2508	(1.450 r.p.m.)	25	6.502,00
HF-4 3008	(1.450 r.p.m.)	30	6.790,00



1.450 r.p.m.

VERT CF-4 CON PREFILTRO VERTICAL A 1,450 RPM

VERT CF-4 300	(1.450 r.p.m.)	3	3.341,00
VERT CF-4 400	(1.450 r.p.m.)	4	3.652,00
VERT CF-4 550	(1.450 r.p.m.)	5,5	3.788,00
VERT CF-4 552	(1.450 r.p.m.)	5,5	4.109,00
VERT CF-4 750	(1.450 r.p.m.)	7,5	4.358,00
VERT CF-4 1000	(1.450 r.p.m.)	10	4.871,00
VERT CF-4 1500	(1.450 r.p.m.)	15	6.136,00
VERT CF-4 2000	(1.450 r.p.m.)	20	6.419,00
VERT CF-4 2500	(1.450 r.p.m.)	25	6.988,00



1.450 r.p.m.

VERT HF-4 VERTICALES PARA GRAN ALTURA A 1,450 RPM

VERT HF-4 308	(1.450 r.p.m.)	3	3.657,00
VERT HF-4 408	(1.450 r.p.m.)	4	3.689,00
VERT HF-4 558	(1.450 r.p.m.)	5,5	3.908,00
VERT HF-4 758	(1.450 r.p.m.)	7,5	4.714,00
VERT HF-4 1208	(1.450 r.p.m.)	10	5.328,00
VERT HF-4 1508	(1.450 r.p.m.)	15	6.145,00
VERT HF-4 2008	(1.450 r.p.m.)	20	6.456,00
VERT HF-4 2508	(1.450 r.p.m.)	25	7.264,00
VERT HF-4 3008	(1.450 r.p.m.)	30	7.552,00

**NO EQUIPAN CONTRABRIDAS / COUNTERFLANGES NOT INCLUDED
COMPATIBLE CON VARIADOR [E]POOL / VSD [E]POOL COMPATIBLE**

	TIPO TYPE	CV HP	PVP € Motor IE-3
--	--------------	----------	---------------------

**BR-2 - CENTRIFUGAS EN BRONCE MARINO**

BR-2 300	3	CONSULTAR
BR-2 400	4	CONSULTAR
BR-2 550	5,5	CONSULTAR
BR-2 551	5,5	CONSULTAR
BR-2 750	7,5	CONSULTAR
BR-2 1000	10	CONSULTAR
BR-2 1250	12,5	CONSULTAR
BR-2 1500	15	CONSULTAR

	TIPO TYPE	Conexiones Connections	PVP € Hierro/Cast iron	PVP € Bronce/Bronze
--	--------------	---------------------------	---------------------------	------------------------

**PREFILTROS COMPLETOS HIERRO Y BRONCE**

F 65 / 65	DN-65	614,00	-
F 80 / 80	DN-80	614,00	CONSULTAR
F 100 / 100	DN-100	662,00	-
F 125 / 125	DN-125	662,00	CONSULTAR
F 150 / 150	DN-150	1.515,00	-
F 200 / 200	DN-200	1.536,00	-



V 65/65	DN-65	1.776,00	-
V 80/80	DN-80	1.776,00	-
V 100/100	DN-100	1.888,00	-
V 125/125	DN-125	1.888,00	-
V 150/150	DN-150	1.888,00	-

	TIPO TYPE	Conexiones Connections	PVP €
--	--------------	---------------------------	-------

PREFILTROS SUELTOS ACERO INOX. AISI 316L

IH 65 / 65	DN-65	2.094,00
IH 80 / 80	DN-80	2.094,00
IH 100 / 100	DN-100	2.094,00
IH 125 / 125	DN-125	2.094,00
IH 150 / 150	DN-150	2.950,00
IH 200 / 200	DN-200	3.400,00

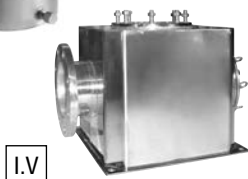

IV 100 / 65 VERT	DN 100-65	2.556,00
IV 100 / 80 VERT	DN 100-80	2.556,00
IV 125 / 100 VERT	DN 125-100	2.556,00
IV 150 / 125 VERT	DN 150-125	3.500,00
IV 200 / 150 VERT	DN 250-150	3.900,00

FILTROS LAMINADOS PISCINA PRIVADA



TIPO TYPE	Ø exterior	Caudal flow lts/h	Ø Ent. Ø Sal.	Arena sand	PVP €
SUN 400	400	6.500	1 1/2"	50 kg.	465,00
SUN 400 (VALV. TOP)	400	6.500	1 1/2"	50 kg.	394,00
SUN 510	510	10.200	1 1/2"	100 kg.	508,00
SUN 510 (VALV. TOP)	510	10.200	1 1/2"	100 kg.	451,00
SUN 620	620	15.100	1 1/2"	150 kg.	568,00
SUN 620 (VALV. TOP)	620	15.100	1 1/2"	150 kg.	508,00
SUN 680	680	18.140	2"	175 kg.	800,00
SUN 680 (VALV. TOP)	680	18.140	2"	175 kg.	561,00
SUN 750	750	22.000	2"	225 kg.	829,00
SUN 900	900	31.800	2"	325 kg.	1.063,00

Filtros de alto rendimiento. No incluyen arena.
High performance filters. Sand not included.



FILTROS LAMINADOS PISCINA PÚBLICA

TIPO TYPE	20 m³/h/m² PVP €	30 m³/h/m² PVP €	40 m³/h/m² PVP €	50 m³/h/m² PVP €
SUN 1050	2.256,00	2.325,00	2.325,00	2.441,00
SUN 1200		2.584,00	2.584,00	2.665,00
SUN 1400	2.707,00	2.852,00	3.241,00	3.241,00
SUN 1600	3.495,00	3.641,00	3.641,00	3.933,00
SUN 1800	4.629,00	4.836,00	5.201,00	5.253,00
SUN 2000	6.035,00	6.235,00	6.705,00	6.839,00

No incluyen batería de válvulas. Lecho filtrante de 1 metro. Incluye brazo colector. Bajo demanda 1,2 mts lecho y placa crepinas.
Battery valves not included. Filtration bed of 1 meter. Includes arm collector. Under demand 1,2 meters of filtration bed and/or Nozzle plate.

SUPLEMENTO BOCA DE HOMBRE

1.132,00

SUPLEMENTO MIRILLA

453,00

FILTROS LAMINADOS ALTO RENDIMIENTO

High performance Laminated Filters



TIPO TYPE	20 m³/h/m² PVP €	30 m³/h/m² PVP €	40 m³/h/m² PVP €	50 m³/h/m² PVP €
FILTRO AR. LAM. SUN D.1050	3.100,00	3.332,00	3.332,00	3.499,00
FILTRO AR. LAM. SUN D.1200		3.679,00	3.679,00	3.999,00
FILTRO AR. LAM. SUN D.1400	4.241,00	4.661,00	4.979,00	4.979,00
FILTRO AR. LAM. SUN D.1600	5.323,00	5.545,00	5.545,00	5.785,00
FILTRO AR. LAM. SUN D.1800	6.530,00	6.824,00	7.336,00	7.447,00
FILTRO AR. LAM. SUN D.2000	7.656,00	7.913,00	8.509,00	8.679,00

BATERÍAS DE 5 VALVULAS



TIPO TYPE	PVP €
BATERÍA 5 VALVULAS DN 75	1.192,00
BATERÍA 5 VALVULAS DN 90	1.424,00
BATERÍA 5 VALVULAS DN 110	1.590,00
BATERÍA 5 VALVULAS DN 125	1.906,00
BATERÍA 5 VALVULAS DN 140	2.084,00
BATERÍA 5 VALVULAS DN 160	2.771,00
BATERÍA 5 VALVULAS DN 200	3.797,00

	TIPO TYPE	CV HP	PVP € Monof/Single ph	PVP € Trif/Three ph
--	--------------	----------	--------------------------	------------------------



BOMBAS DOSIFICADORAS

PL 23			320,00	-
PL 50			521,00	-
PL 75			543,00	-
DOSING KIT PH 1,5 lts a 1,5 bar			683,00	-
DOSING KIT RX 1,5 lts a 1,5 bar			683,00	-



POOLMATIC BOMBAS LIMPIAFONDOS AUTOMÁTICO

POOLMATIC 30 / 50	0,75	386,00	366,00
POOLMATIC 40 / 50	1	450,00	461,00

BOMBAS SOPLANTES



BLOWER 80-400	0,6	606,00	606,00
BLOWER 140-850	1,2	760,00	760,00
BLOWER 140-131	1,8	810,00	810,00
BLOWER 210-131	1,8	891,00	891,00
BLOWER 210-151	2	983,00	-
BLOWER 210-161	2,2	-	943,00
BLOWER 315-221	3	-	1.378,00
BLOWER 315-301	4	-	1.539,00

	TIPO TYPE	CV HP	PVP €
--	--------------	----------	-------



DIVERTECH - SUMERGIBLES DOMÉSTICAS

DIVERTECH 63 M Aut	0,6	459,00
DIVERTECH 103 M Aut	1	502,00
DIVERTECH 103 T	1	471,00
DIVERTECH 153 M Aut	1,5	568,00
DIVERTECH 153 T	1,5	538,00
DIVERTECH HF 154 M Aut	1,5	568,00
DIVERTECH HF 154 T	1,5	538,00
DIVERTECH HF 204 M Aut	2	668,00
DIVERTECH HF 204 T	2	637,00

ANODO DE SACRIFICIO (99,8% ZINC) **57,00**



CAMISAS DE REFRIGERACIÓN

CAMISAS DE REFRIGERACIÓN 4" (DIAMETRO 105)	332,00
CAMISAS DE REFRIGERACIÓN 6" (DIAMETRO 200)	652,00

	TIPO TYPE	CV HP	PVP € Bomba Suelta Only Pump	Bomba + Motor FR PVP €		Bomba + Motor Franklin PVP €	
				Monof.	Trif.	Monof.	Trif.
AR - SUMERGIBLES 4" TURBINA FLOTANTE							
	AR 15-19	0,75	181,00	446,00	442,00	620,00	608,00
	AR 15-26	1	246,00	529,00	523,00	718,00	701,00
	AR 15-38	1,5	353,00	679,00	675,00	898,00	880,00
	AR 20-15	0,75	172,00	437,00	433,00	611,00	599,00
	AR 20-20	1	200,00	483,00	477,00	672,00	655,00
	AR 20-30	1,5	302,00	628,00	624,00	847,00	829,00
	AR 20-36	2	359,00	725,00	709,00	1.027,00	962,00
	AR 30-10	0,75	138,00	403,00	399,00	577,00	565,00
	AR 30-14	1	163,00	446,00	440,00	635,00	618,00
	AR 30-20	1,5	201,00	527,00	523,00	746,00	728,00
	AR 40-11	1	140,00	423,00	417,00	612,00	595,00
	AR 40-16	1,5	174,00	500,00	496,00	719,00	701,00
	AR 40-21	2	207,00	573,00	557,00	875,00	810,00
	AR 40-32	3	276,00	750,00	729,00	1.118,00	1.022,00
	AR 60-07	0,75	126,00	391,00	387,00	565,00	553,00
	AR 60-09	1	138,00	421,00	415,00	610,00	593,00
	AR 60-14	1,5	175,00	501,00	497,00	720,00	702,00
	AR 60-18	2	207,00	573,00	557,00	875,00	810,00
	AR 60-27	3	270,00	744,00	723,00	1.112,00	1.016,00
	AR 60-35	4	360,00	-	939,00	-	1.471,00
AR 60-48	5,5	454,00	-	1.173,00	-	1.706,00	
AR 110-07	1	142,00	425,00	419,00	614,00	597,00	
AR 110-10	1,5	182,00	508,00	504,00	727,00	709,00	
AR 110-14	2	207,00	573,00	557,00	875,00	810,00	
AR 110-20	3	266,00	740,00	719,00	1.108,00	1.012,00	
AR 110-27	4	326,00	-	905,00	-	1.437,00	
AR 110-36	5,5	441,00	-	1.160,00	-	1.693,00	
AR 140-06	1,5	138,00	464,00	460,00	683,00	665,00	
AR 140-08	2	155,00	521,00	505,00	823,00	758,00	
AR 140-13	3	210,00	684,00	663,00	1.052,00	956,00	
AR 140-17	4	244,00	-	823,00	-	1.355,00	
AR 140-23	5,5	309,00	-	1.028,00	-	1.561,00	
AR 140-32	7,5	399,00	-	1.227,00	-	1.854,00	
AR 200-07	2	197,00	563,00	547,00	865,00	800,00	
AR 200-10	3	248,00	722,00	701,00	1.090,00	994,00	
AR 200-14	4	316,00	-	895,00	-	1.427,00	
AR 200-19	5,5	423,00	-	1.142,00	-	1.675,00	
AR 200-26	7,5	571,00	-	1.399,00	-	2.026,00	
AR 250-08	3	253,00	727,00	706,00	1.095,00	999,00	
AR 250-11	4	326,00	-	905,00	-	1.437,00	
AR 250-15	5,5	419,00	-	1.138,00	-	1.671,00	
AR 250-20	7,5	535,00	-	1.363,00	-	1.990,00	

*** LAS BOMBAS MONOFASICAS INCLUYEN CONDENSADOR DE ARRANQUE

*** LAS BOMBAS CON MOTOR SE ENTREGARAN DESMONTADAS (BOMBA Y MOTOR SUELTO) PARA EVITAR ROTURAS EN TRANSPORTE.

*** LAS BOMBAS TRIFASICAS MUESTRAN PRECIOS CON MOTORES TRIFASICOS A 400 V

	TIPO TYPE	CV HP	PVP €	Bomba + Motor		Bomba + Motor		
			Bomba Suelta Only Pump	FR PVP € Monof.	Trif.	Franklin PVP € Monof.	Trif.	
SP - SUMERGIBLES 4" AISI-304								
	SP 10-13	0,75	278,00	543,00	539,00	717,00	705,00	
	SP 10-18	1	352,00	635,00	629,00	824,00	807,00	
	SP 10-23	1,5	427,00	753,00	749,00	972,00	954,00	
	SP 10-33	2	621,00	987,00	971,00	1.289,00	1.224,00	
	SP 10-48	3	941,00	1.415,00	1.394,00	1.783,00	1.687,00	
	SP 18-09	0,75	221,00	486,00	482,00	660,00	648,00	
	SP 18-12	1	266,00	549,00	543,00	738,00	721,00	
	SP 18-18	1,5	352,00	678,00	674,00	897,00	879,00	
	SP 18-25	2	458,00	824,00	808,00	1.126,00	1.061,00	
	SP 18-33	3	621,00	1.095,00	1.074,00	1.463,00	1.367,00	
	SP 18-45	4	893,00	-	1.472,00	-	2.004,00	
	SP 25-06	0,75	186,00	451,00	447,00	625,00	613,00	
	SP 25-08	1	215,00	498,00	492,00	687,00	670,00	
	SP 25-12	1,5	271,00	597,00	593,00	816,00	798,00	
	SP 25-17	2	347,00	713,00	697,00	1.015,00	950,00	
	SP 25-21	3	406,00	880,00	859,00	1.248,00	1.152,00	
	SP 25-25	3	469,00	943,00	922,00	1.311,00	1.215,00	
	SP 25-33	4	621,00	-	1.200,00	-	1.732,00	
	SP 25-44	5,5	879,00	-	1.598,00	-	2.131,00	
	SP 40-07	1,5	418,00	744,00	740,00	963,00	945,00	
	SP 40-10	2	542,00	908,00	892,00	1.210,00	1.145,00	
	SP 40-15	3	742,00	1.216,00	1.195,00	1.584,00	1.488,00	
	SP 40-18	4	861,00	-	1.440,00	-	1.972,00	
	SP 40-25	5,5	1.143,00	-	1.862,00	-	2.395,00	
	SP 70-07	3	568,00	1.042,00	1.021,00	1.410,00	1.314,00	
SP 70-10	4	748,00	-	1.327,00	-	1.859,00		
SP 70-13	5,5	927,00	-	1.646,00	-	2.179,00		
SP 70-18	7,5	1.076,00	-	1.904,00	-	2.531,00		
SP 70-25	10	1.494,00	-	2.468,00	-	3.453,00		

*** LAS BOMBAS MONOFASICAS INCLUYEN CONDENSADOR DE ARRANQUE

*** LAS BOMBAS CON MOTOR SE ENTREGARAN DESMONTADAS (BOMBA Y MOTOR SUELTO) PARA EVITAR ROTURAS EN TRANSPORTE.

*** LAS BOMBAS TRIFASICAS MUESTRAN PRECIOS CON MOTORES TRIFASICOS A 400 V



TIPO TYPE	CV HP	PVP € Bomba Suelta Only Pump	Bomba + Motor SACI PVP €	Bomba + Motor Franklin PVP €
--------------	----------	------------------------------------	-----------------------------	---------------------------------

AS - SUMERGIBLES 6" RADIALES

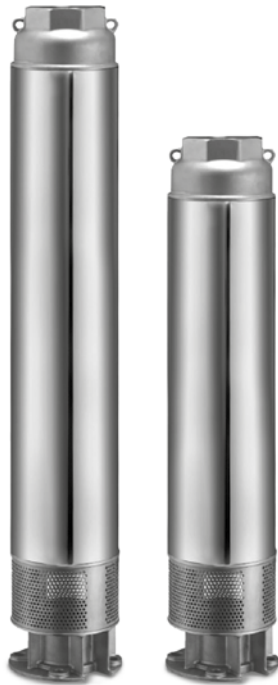

AS6 75-6	5,5 - 4"	667,00	1.386,00	1.919,00
AS6 75-09	7,5 - 4"	750,00	1.578,00	2.205,00
AS6 75-12	10	893,00	2.781,00	3.330,00
AS6 75-15	12,5	977,00	2.971,00	3.572,00
AS6 75-18	15	1.061,00	3.178,00	3.774,00
AS6 75-24	20	1.229,00	3.677,00	4.359,00
AS6 135-4	5,5 - 4"	634,00	1.353,00	1.886,00
AS6 135-6	7,5 - 4"	701,00	1.529,00	2.156,00
AS6 135-8	10	826,00	2.714,00	3.263,00
AS6 135-10	12,5	894,00	2.888,00	3.489,00
AS6 135-12	15	962,00	3.079,00	3.675,00
AS6 135-16	20	1.096,00	3.544,00	4.226,00
AS6 135-20	25	1.267,00	3.957,00	4.645,00
AS6 135-24	30	1.403,00	4.363,00	5.170,00
AS6 180-3	5,5 - 4"	645,00	1.364,00	1.897,00
AS6 180-4	7,5 - 4"	682,00	1.510,00	2.137,00
AS6 180-5	10	781,00	2.669,00	3.218,00
AS6 180-6	12,5	818,00	2.812,00	3.413,00
AS6 180-8	15	953,00	3.070,00	3.666,00
AS6 180-10	20	1.095,00	3.543,00	4.225,00
AS6 180-13	25	1.223,00	3.913,00	4.601,00
AS6 180-15	30	1.306,00	4.266,00	5.073,00
AS6 220-3	7,5 - 4"	643,00	1.471,00	2.098,00
AS6 220-4	10	794,00	2.682,00	3.231,00
AS6 220-5	12,5	832,00	2.826,00	3.427,00
AS6 220-6	15	871,00	2.988,00	3.584,00
AS6 220-9	20	988,00	3.436,00	4.118,00
AS6 220-11	25	1.068,00	3.758,00	4.446,00
AS6 220-14	30	1.184,00	4.144,00	4.951,00

*TODOS LOS MOTORES DE 5,5 Y 7,5 CV SON DE 4" Y PARA POTENCIAS DE 10 A 30 CV EQUIPAN MOTOR CON ARRANQUE ESTRELLA TRIANGULO.
* FOR POWERS OF UP TO 7,5 HP, THE MOTOR IS 4". FROM 10 HP, THE MOTORS ARE 6".

	TIPO TYPE	CV HP	PVP € Bomba Suelta Only Pump	Bomba + Motor SACI PVP €	Bomba + Motor Franklin PVP €
--	--------------	----------	------------------------------------	-----------------------------	---------------------------------

SX - SUMERGIBLES SEMIAXIALES 6"-8"-10"

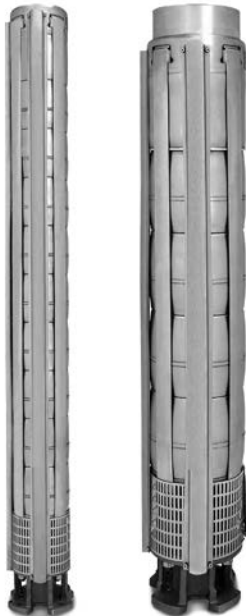

SX 617-06	5,5 - 6"	896,00	2.491,00	-
SX 617-08	7,5	988,00	2.677,00	3.313,00
SX 617-10	7,5	1.166,00	2.855,00	3.491,00
SX 617-11	10	1.257,00	3.145,00	3.694,00
SX 617-13	10	1.434,00	3.322,00	3.871,00
SX 617-15	12,5	1.613,00	3.607,00	4.208,00
SX 617-17	15	1.787,00	3.904,00	4.500,00
SX 617-18	15	1.878,00	3.995,00	4.591,00
SX 617-20	15	2.057,00	4.174,00	4.770,00
SX 617-24	20	2.409,00	4.857,00	5.539,00
SX 617-27	20	2.670,00	5.118,00	5.800,00
SX 617-29	25	2.852,00	5.542,00	6.230,00
SX 617-33	25	3.205,00	5.895,00	6.583,00
SX 617-36	30	3.473,00	6.433,00	7.240,00
SX 617-40	30	3.825,00	6.785,00	7.592,00
SX 617-48	35	7.316,00	10.601,00	12.086,00
SX 617-53	40	7.983,00	11.363,00	12.753,00
SX 617-55	50	8.363,00	12.127,00	15.283,00
SX 630-04	5,5 - 6"	776,00	2.371,00	-
SX 630-06	7,5	988,00	2.677,00	3.313,00
SX 630-08	10	1.191,00	3.079,00	3.628,00
SX 630-11	12,5	1.497,00	3.491,00	4.092,00
SX 630-13	15	1.704,00	3.821,00	4.417,00
SX 630-15	17,5	1.908,00	4.204,00	5.038,00
SX 630-17	20	2.127,00	4.575,00	5.257,00
SX 630-19	25	2.343,00	5.033,00	5.721,00
SX 630-21	25	2.595,00	5.285,00	5.973,00
SX 630-23	30	2.844,00	5.804,00	6.611,00
SX 630-26	30	3.171,00	6.131,00	6.938,00
SX 630-28	35	3.393,00	6.678,00	8.163,00
SX 630-30	35	3.605,00	6.890,00	8.375,00
SX 630-32	40	3.817,00	7.197,00	8.587,00
SX 630-35	40	4.176,00	7.556,00	8.946,00
SX 630-39	50	8.077,00	11.841,00	14.997,00
SX 630-43	50	8.649,00	12.413,00	15.569,00

TIPO TYPE	CV HP	PVP € Bomba Suelta Only Pump	Bomba + Motor SACI PVP €	Bomba + Motor Franklin PVP €
--------------	----------	------------------------------------	-----------------------------	---------------------------------

SX - SUMERGIBLES SEMIAXIALES 6"-8"-10"

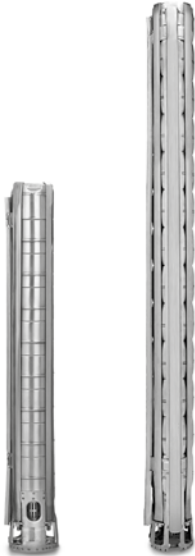

SX 646-03	7,5	768,00	2.457,00	3.093,00
SX 646-05	10	1.041,00	2.929,00	3.478,00
SX 646-06	12,5	1.178,00	3.172,00	3.773,00
SX 646-07	15	1.306,00	3.423,00	4.019,00
SX 646-08	17,5	1.444,00	3.740,00	4.574,00
SX 646-09	20	1.580,00	4.028,00	4.710,00
SX 646-10	20	1.730,00	4.178,00	4.860,00
SX 646-11	25	1.874,00	4.564,00	5.252,00
SX 646-12	25	2.027,00	4.717,00	5.405,00
SX 646-14	30	2.317,00	5.277,00	6.084,00
SX 646-15	30	2.450,00	5.410,00	6.217,00
SX 646-16	35	2.578,00	5.863,00	7.348,00
SX 646-17	35	2.736,00	6.021,00	7.506,00
SX 646-18	40	2.897,00	6.277,00	7.667,00
SX 646-20	40	3.195,00	6.575,00	7.965,00
SX 646-22	50	3.510,00	7.274,00	10.430,00
SX 646-24	50	3.803,00	7.567,00	10.723,00

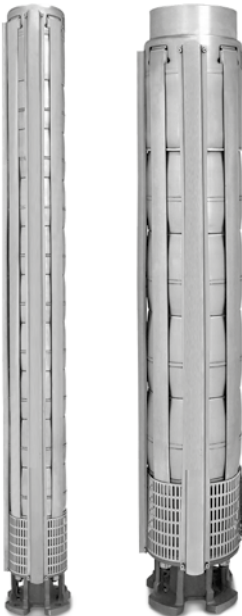

SX 660-02	5,5-6"	632,00	2.227,00	-
SX 660-03	7,5	768,00	2.457,00	3.093,00
SX 660-04	10	906,00	2.794,00	3.343,00
SX 660-05	12,5	1.041,00	3.035,00	3.636,00
SX 660-06	15	1.178,00	3.295,00	3.891,00
SX 660-07	17,5	1.306,00	3.602,00	4.436,00
SX 660-08	20	1.459,00	3.907,00	4.589,00
SX 660-09	25	1.601,00	4.291,00	4.979,00
SX 660-10	25	1.734,00	4.424,00	5.112,00
SX 660-11	30	1.895,00	4.855,00	5.662,00
SX 660-12	30	2.057,00	5.017,00	5.824,00
SX 660-13	35	2.218,00	5.503,00	6.988,00
SX 660-15	40	2.525,00	5.905,00	7.295,00
SX 660-17	40	2.818,00	6.198,00	7.588,00
SX 660-18	50	2.960,00	6.724,00	9.880,00
SX 660-19	50	3.108,00	6.872,00	10.028,00
SX 660-20	50	3.246,00	7.010,00	10.166,00
SX 660-21	50	3.393,00	7.157,00	10.313,00

TIPO TYPE	CV HP	PVP € Bomba Suelta Only Pump	Bomba + Motor SACI PVP €	Bomba + Motor Franklin PVP €
--------------	----------	------------------------------------	-----------------------------	---------------------------------

SX - SUMERGIBLES SEMIAXIALES 6"-8"-10"



SX 896-01	6"-7,5	1.423,00	3.112,00	3.748,00
SX 896-02	6"-15	1.697,00	3.814,00	4.410,00
SX 896-03	6"-20	1.968,00	4.416,00	5.098,00
SX 896-04	6"-30	2.238,00	5.198,00	6.005,00
SX 896-05	8"-40-R	2.453,00	6.937,00	9.993,00
SX 896-06	8"-50-R	2.674,00	7.461,00	10.897,00
SX 896-07	8"-50-R	2.942,00	7.729,00	11.165,00
SX 896-08	8"-60-R	3.216,00	8.324,00	11.944,00
SX 896-09	8"-60-R	3.435,00	8.543,00	12.163,00
SX 896-10	8"-75-R	3.758,00	9.270,00	13.683,00
SX 896-11	8"-80-R	4.003,00	9.669,00	14.250,00
SX 896-12	8"-90-R	4.248,00	10.260,00	15.505,00
SX 896-13	8"-100-R	4.521,00	10.878,00	16.364,00
SX 896-14	8"-100-R	4.793,00	11.150,00	16.636,00
SX 896-15	8"-110-R	5.022,00	11.658,00	17.755,00
SX 896-17	8"-125-R	5.499,00	12.568,00	19.343,00



SX 10126-01	6"-15	2.507,00	4.624,00	5.220,00
SX 10126-02	6"-30	2.818,00	5.778,00	6.585,00
SX 10126-03	8"-50 R	3.133,00	7.920,00	11.356,00
SX 10126-04	8"-60 R	3.655,00	8.763,00	12.383,00
SX 10126-05	8"-75 R	4.073,00	9.585,00	13.998,00
SX 10126-06	8"-90 R	4.438,00	10.450,00	15.695,00
SX 10126-07	8"-100 R	5.092,00	11.449,00	16.935,00
SX 10126-08	8"-125 R	5.614,00	12.683,00	19.458,00
SX 10126-09	10"-150 R	6.083,00	16.009,00	21.818,00
SX 10126-10	10"-150 R	6.579,00	16.505,00	22.314,00
SX 10126-11	10"-175 R	6.993,00	18.303,00	24.092,00
SX 10126-12	10"-175 R	7.441,00	18.751,00	24.540,00
SX 10126-13	10"-200 R	8.091,00	20.699,00	26.374,00

TIPO TYPE	CV HP	PVP € Bomba Suelta Only Pump	Bomba + Motor SACI PVP €	Bomba + Motor Franklin PVP €
--------------	----------	------------------------------------	-----------------------------	---------------------------------

SX - SUMERGIBLES SEMIAJIALES 6"-8"-10"

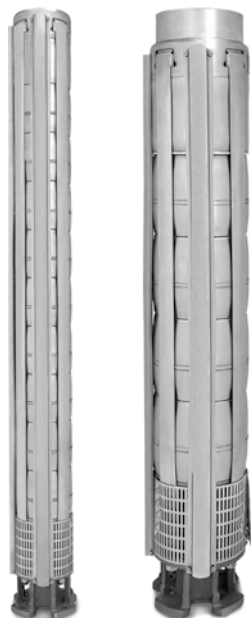

SX 10160-01	6"-17,5	2.661,00	4.957,00	5.791,00
SX 10160-02B	6"-25	2.997,00	5.687,00	6.375,00
SX 10160-02B	6"-35	2.997,00	6.282,00	7.767,00
SX 10160-03B	8"-40 R	3.332,00	7.816,00	10.872,00
SX 10160-03	8"-50 R	3.332,00	8.119,00	11.555,00
SX 10160-04	8"-60 R	3.878,00	8.986,00	12.606,00
SX 10160-05	8"-75 R	4.326,00	9.838,00	14.251,00
SX 10160-06B	8"-80 R	4.724,00	10.390,00	14.971,00
SX 10160-06	8"-90 R	4.724,00	10.736,00	15.981,00
SX 10160-07B	8"-100 R	5.419,00	11.776,00	17.262,00
SX 10160-07	8"-110 R	5.419,00	12.055,00	18.152,00
SX 10160-08	8"-125 R	5.978,00	13.047,00	19.822,00
SX 10160-09	10"-150 R	6.475,00	16.401,00	22.210,00
SX 10160-10	10"-150 R	6.985,00	16.911,00	22.720,00
SX 10160-11	10"-175 R	7.432,00	18.742,00	24.531,00
SX 10160-12	10"-200 R	7.929,00	20.537,00	26.212,00
SX 10160-13	10"-200 R	8.649,00	21.257,00	26.932,00
SX 10210-01B	6"-20	6.049,00	8.497,00	9.179,00
SX 10210-01	6"-25	6.049,00	8.739,00	9.427,00
SX 10210-02B2	8"-40 R	6.907,00	11.391,00	14.447,00
SX 10210-02	8"-50 R	6.907,00	11.694,00	15.130,00
SX 10210-03B3	8"-60 R	7.871,00	12.979,00	16.599,00
SX 10210-03	8"-75 R	7.871,00	13.383,00	17.796,00
SX 10210-04B2	8"-90 R	8.841,00	14.853,00	20.098,00
SX 10210-04	8"-100 R	8.841,00	15.198,00	20.684,00
SX 10210-05	8"-125 R	9.806,00	16.875,00	23.650,00
SX 10210-06	10"-150 R	10.829,00	20.755,00	26.564,00
SX 10210-07	10"-175 R	11.905,00	23.215,00	29.004,00
SX 10210-08	10"-200 R	12.982,00	25.590,00	31.265,00
SX 10210-09	10"-225 R	14.058,00	28.481,00	34.190,00
SX 10210-10	10"-250 R	15.136,00	29.559,00	35.268,00

TIPO TYPE	PVP €
--------------	-------

RYLBRUN TUBERÍA FLEXIBLE PARA BOMBAS SUMERGIBLES

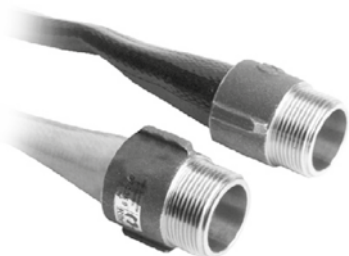

MANGUERA 1 1/4" AZUL PN 15	15,50
MANGUERA 1 1/4" AZUL CON ALETA PN 30	22,00
MANGUERA 2" GRIS PN 10	24,00
MANGUERA 2" NEGRA PN 26	42,00
MANGUERA 3" PN 25	66,00
MANGUERA 4" PN 25	80,00
RACOR EXPANSION 1 1/4"	51,00
RACOR CONICO 2"	337,00
RACOR CONICO 3"	772,00
RACOR CONICO 4"	1.140,00
CASQ. SIST VACIADO 1 1/4"	585,00
FUSIBLE. SIST VACIADO 1 1/4"	32,00
PLOMADA. SIST VACIADO 1 1/4"	112,00

TIPO TYPE	CV HP	PVP € Monof/Single ph	PVP € Trif/Three ph
--------------	----------	--------------------------	------------------------



FR - MOTORES SACI 4"

4"

FR 0,75 CV (1.500 KGS C.AXIAL)	265,00	261,00
FR 1 CV (2.500 KGS C.AXIAL)	283,00	277,00
FR 1,5 CV (2.500 KGS C.AXIAL)	326,00	322,00
FR 2 CV (4.500 KGS C.AXIAL)	366,00	350,00
FR 3 CV (4.500 KGS C.AXIAL)	474,00	453,00
FR 4 CV (4.500 KGS C.AXIAL)	-	579,00
FR 5,5 CV (4.500 KGS C.AXIAL)	-	719,00
FR 7,5 CV (4.500 KGS C.AXIAL)	-	828,00
FR 1000 10 CV	-	974,00

LOS PRECIOS DE LOS MOTORES MONOFASICOS INCLUYEN LOS CONDENSADORES DE ARRANQUE
LOS MOTORES FR DE VOLTAJE 230V TRIFASICOS TIENEN UN 5% DE INCREMENTO SOBRE LOS TRIFASICOS 400V



MOTORES FRANKLIN 4"

4"

FRANKLIN 0,5 CV	425,00	422,00
FRANKLIN 0,75 CV	439,00	427,00
FRANKLIN 1 CV	472,00	455,00
FRANKLIN 1,5 CV	545,00	527,00
FRANKLIN 2 CV	668,00	603,00
FRANKLIN 3	842,00	746,00
FRANKLIN 4 CV NORMAL	-	945,00
FRANKLIN 4 CV SUPER	-	1.111,00
FRANKLIN 5 CV	-	1.166,00
FRANKLIN 5,5	-	1.252,00
FRANKLIN 7,5	-	1.455,00
FRANKLIN 10	-	1.959,00

LOS PRECIOS DE LOS MOTORES MONOFASICOS INCLUYEN LOS CONDENSADORES DE ARRANQUE

TIPO TYPE	CV HP	PVP € A. directo/Direct	PVP € A. Est-Triang/Star Delta
--------------	----------	----------------------------	-----------------------------------

MOTORES SACI REBOBINABLES REFRIG. POR AGUA 6"-8"-10"

6"

MOTOR REBOBINABLE

6" MOT 5.5	1.595,00	1.595,00
6" MOT 7.5	1.689,00	1.689,00
6" MOT 10	1.888,00	1.888,00
6" MOT 12.5	1.994,00	1.994,00
6" MOT 15	2.117,00	2.117,00
6" MOT 17.5	2.296,00	2.296,00
6" MOT 20	2.448,00	2.448,00
6" MOT 25	2.690,00	2.690,00
6" MOT 30	2.960,00	2.960,00
6" MOT 35	3.285,00	3.285,00
6" MOT 40	3.380,00	3.380,00
6" MOT 50	3.764,00	3.764,00



TIPO TYPE	CV HP	PVP € A. directo/Direct	PVP € A. Est-Triang/Star Delta
--------------	----------	----------------------------	-----------------------------------

MOTORES SACI REBOBINABLES REFRIG. POR AGUA 6"-8"-10"



8"

MOTOR
REBOBINABLE

8" MOT 40	4.484,00	4.484,00
8" MOT 50	4.787,00	4.787,00
8" MOT 60	5.108,00	5.108,00
8" MOT 75	5.512,00	5.512,00
8" MOT 80	5.666,00	5.666,00
8" MOT 90	6.012,00	6.012,00
8" MOT 100	6.357,00	6.357,00
8" MOT 110	6.636,00	6.636,00
8" MOT 125	7.069,00	7.069,00

10"

MOTOR
REBOBINABLE

10" MOT 125	8.868,00	8.868,00
10" MOT 150	9.926,00	9.926,00
10" MOT 175	11.310,00	11.310,00
10" MOT 200	12.608,00	12.608,00
10" MOT 250	14.423,00	14.423,00

MOTORES FRANKLIN ENCAPSULADOS 6"-8"



6"

MOTOR
ENCAPSULADO

6" MOT 5.5	2.096,00	-
6" MOT 7.5	2.163,00	2.325,00
6" MOT 10	2.275,00	2.437,00
6" MOT 12.5	2.432,00	2.595,00
6" MOT 15	2.551,00	2.713,00
6" MOT 20	2.967,00	3.130,00
6" MOT 25	3.216,00	3.378,00
6" MOT 30	3.605,00	3.767,00
6" MOT 40	4.666,00	4.770,00
6" MOT 50	6.807,00	6.920,00
6" MOT 60	8.105,00	8.338,00

8"

MOTOR
ENCAPSULADO

8" MOT 40	8.184,00	8.909,00
8" MOT 50	8.799,00	9.525,00
8" MOT 60	9.512,00	10.238,00
8" MOT 75	10.776,00	11.725,00
8" MOT 100	13.547,00	14.497,00
8" MOT 125	17.887,00	18.837,00
8" MOT 150	21.629,00	22.753,00
8" MOT 175	24.216,00	25.341,00
8" MOT 200	29.987,00	31.112,00

TIPO TYPE	CV HP	PVP € A. directo/Direct	PVP € A. Est-Triang/Star Delta
--------------	----------	----------------------------	-----------------------------------

MOTORES FRANKLIN REBOBINABLES 6"-8"-10"



6"
MOTOR
REBOBINABLE

6" MOT 5.5	2.465,00	2.621,00
6" MOT 7.5	2.465,00	2.621,00
6" MOT 10	2.580,00	2.737,00
6" MOT 12.5	2.637,00	2.790,00
6" MOT 15	2.735,00	2.887,00
6" MOT 17.5	2.943,00	3.095,00
6" MOT 20	3.247,00	3.399,00
6" MOT 25	3.658,00	3.810,00
6" MOT 30	4.072,00	4.224,00
6" MOT 35	4.431,00	4.583,00
6" MOT 40	4.813,00	4.962,00
6" MOT 50	6.475,00	6.626,00

8"
MOTOR
REBOBINABLE

8" MOT 40	6.938,00	7.540,00
8" MOT 50	7.621,00	8.223,00
8" MOT 60	8.126,00	8.728,00
8" MOT 70	8.977,00	9.591,00
8" MOT 75	9.136,00	9.925,00
8" MOT 80	9.661,00	10.247,00
8" MOT 90	10.733,00	11.257,00
8" MOT 100	11.047,00	11.843,00
8" MOT 112	12.014,00	12.733,00
8" MOT 125	13.048,00	13.844,00

10"
MOTOR
REBOBINABLE

10" MOT 125	-	15.098,00
10" MOT 150	-	15.735,00
10" MOT 175	-	17.099,00
10" MOT 200	-	18.283,00
10" MOT 250	-	20.132,00

	TIPO TYPE	CV HP	PVP € BOMBA/Pump
--	--------------	----------	---------------------



VORT - SUMERGIBLES FECALES VORTEX AISI-304

VORT 7 M AUT	0,75	302,00
VORT 10 M AUT	1	348,00
VORT 15 M AUT	1,5	398,00
VORT 15 T	1,5	322,00
VORT 20 T	2	361,00



VG - SUMERGIBLES FECALES VORTEX

VG 05 M AUT	0,5	299,00
VG 10 M AUT	1	424,00
VG 10 T	1	388,00
VG 20 M AUT	2	696,00
VG 20 T	2	624,00
VG 30 T	3	709,00
VG 50 T	5	1.152,00

*Para más info consulte nuestra web / For more info see our website.

COMPACTA - SUMERGIBLES VORTEX

COMPACTA 1 M AUT	0,4	287,00
COMPACTA 2 M AUT	0,8	397,00
COMPACTA 2 T	0,8	383,00
COMPACTA 3 M AUT	1	448,00
COMPACTA 3 T	1	432,00
COMPACTA 22 M AUT	0,8	469,00
COMPACTA 22 T	0,8	456,00
COMPACTA 32 M AUT	1	520,00
COMPACTA 32 T	1	506,00
COMPACTA 4 M AUT	1,5	732,00
COMPACTA 4 T	1,5	713,00
COMPACTA 55 M AUT	2	850,00
COMPACTA 55 T	2	795,00
COMPACTA 6 T	3	987,00

COMPACTA PRO 4 T (ATEX)	1,5	1.039,00
COMPACTA PRO 6 T (ATEX)	3	1.180,00

VN - SUMERGIBLES VORTEX AISI-316

VN 05 M AUT	0,5	821,00
VN 10 M AUT	1	1.159,00
VN 30 T-50	3	1.992,00
VN 50 T-80	5	2.806,00
VN 75 T-80	7,5	3.492,00

*Incluye codo salida / Includes outlet elbow

*Para info técnica consulte nuestra web / For more info see our website



HT - SUMERGIBLES AGUAS CARGADAS GRANDES ALTURAS

HT 50-2 C.500	2	1.603,00
HT 50-2 C.501	3	1.724,00
HT 65-2 C.502	4	2.354,00
HT 65-2 C.503	5,5	3.053,00
HT 65-2 C.504	7,5	3.804,00
HT 65-2 C.505	10	4.131,00



	TIPO TYPE	CV HP	PVP € BOMBA/Pump
--	--------------	----------	---------------------



GRIX - GX - GT SUMERGIBLES CON TRITURADOR

GRIX 32-2 C.90 M Aut	1,2	797,00
GRIX 32-2 C.90 T	1,2	720,00
GRIX 32-2 C.110 M Aut	1,5	1.068,00
GRIX 32-2 C.110 T	1,5	951,00
GX 50-2 C. 220 T	3	1.483,00
GT 50-2 C.165 T + BASE	4,5	2.977,00
GT 50-2 C.170 T + BASE	6	3.751,00
GT 50-2 C.175 T + BASE	8,5	5.051,00
GT 50-2 C.180 T + BASE	10,5	5.685,00
GT 50-2 C.185 T + BASE	13	6.397,00
GRINDER 1400 M + CUADRO	1,5	2.098,00
GRINDER 1800 T	2	1.654,00

M - SUMERGIBLES FECALES TURBINA MONOCANAL

Modelos a 2.850 r.p.m.

M 65-2 C.236	2	1.490,00
M 65-2 C.237	3	1.728,00
M 65-2 C.247	5,5	3.053,00
M 80-2 C.254	7,5	3.837,00
M 80-2 C.257	10	4.378,00
M 80-2 C.267	16	6.404,00
M 80-2 C.268	20	7.939,00
M 80-2 C.269	27	9.188,00
M 80-2 C.270	34	10.284,00
M 80-2 C.271	41	12.365,00



Modelos a 1.450 r.p.m.

M 80-4 C.242	2	1.733,00
M 80-4 C.244	3	2.141,00
M 80-4 C.245	4	2.377,00
M 100-4 C.243	2,2	2.102,00
M 100-4 C.244	3	2.363,00
M 100-4 C.245	4	2.624,00
M 100-4 C.255	5,5	3.569,00
M 100-4 C.256	7,5	4.162,00
M 150-4 C.258	10	5.701,00
M 150-4 C.260	13,5	6.843,00
M 150-4 C.263	22,5	7.610,00
M 150-4 C.264	16	7.777,00
M 150-4 C.265	22	10.338,00
M 150-4 C.275	24	12.500,00
M 150-4 C.280	31	14.473,00
M 150-4 C.285	40	17.518,00
M 150-4 C.290	53,5	21.642,00
M 150-4 C.295	61	25.131,00
M 150-4 C.300	68	25.700,00

	TIPO TYPE	CV HP	PVP € BOMBA/Pump
--	--------------	----------	---------------------

VT - SUMERGIBLES FECALES TURBINA VORTEX



VT 80-4 C.341	1,5	1.565,00
VT 80-4 C.342	1,7	1.681,00
VT 80-4 C.344	3	2.136,00
VT 80-4 C.345	4	2.377,00
VT 100-4 C.349	3	2.363,00
VT 100-4 C.350	4	2.624,00
VT 100-4 C.355	5,5	3.569,00
VT 100-4 C.356	7,5	4.162,00
VT 100-4 C.358	10	5.160,00
VT 100-4 C.362	15	6.726,00
VT 100-4 C.363	20	8.409,00
VT 100-4 C.375	30	13.667,00
VT 100-4 C.380	35	15.839,00
VT 150-4 C.385	40	17.518,00
VT 150-4 C.390	50	21.642,00
VT 150-4 C.395	59	25.131,00

DRX - SUMERGIBLES DRENAJE AISI-304



MINI DRX M	0,33	220,00
MINI DRX M AUT	0,33	236,00
DISPOSITIVO ASPIRACIÓN MINI DRX (3mm)		9,00
DRX 7 M AUT	0,75	355,00
DRX 10 M AUT	1	381,00
DRX 10 T	1	355,00
DRX 15 M AUT	1,5	421,00
DRX 15 T	1,5	388,00
DRX 20 T	2	434,00

DG - SUMERGIBLES DRENAJE FUNDICIÓN HIERRO

DG 20 T	2	624,00
DG 30 T	3	709,00
DG 50 T	5	1.152,00

*Incluye codo salida / Includes outlet elbow

*Para info técnica consulte nuestra web / For more info see our website

ZOCALOS DE ACOPLAMIENTO BOMBAS AGUAS FECALES



MINIZOCALO 2"	161,00
ZOCALO DN-65 PN 10	334,00
ZOCALO DN-65 PN 6	481,00
ZOCALO DN-80	701,00
ZOCALO DN-100	936,00
ZOCALO DN-150 (sólo para M 150-4 C.258)	1.319,00
ZOCALO DN-150 (para todas M 150 excepto C.258)	1.839,00

FEKAFOS - KIT ESTACIONES AUTOMÁTICAS



KIT FEKABOX 110 LTS	402,00
KIT FEKABOX 200 LTS	825,00
KIT FEKAFOS 280 LTS	1.420,00
KIT FEKAFOS 280 LTS DOBLE	1.675,00
KIT FEKAFOS 550 LTS DOBLE	2.200,00
KIT FEKAFOS 1200 LTS DOBLE DN 65	4.606,00
KIT FEKAFOS 2000 LTS DOBLE DN 65	6.823,00
KIT FEKAFOS 3800 LTS DOBLE DN 65	9.729,00

LOS PRECIOS DE LOS KITS FEKABOX/FEKAFOS NO INCLUYEN LA BOMBA

	TIPO TYPE	PVP € RETENCIÓN	PVP € COMPERTA
--	--------------	--------------------	-------------------



Válvula Retención



Válvula Compuerta

VÁLVULAS PARA AGUAS FECALES

1 1/4" ROSCA	81,00	-
1 1/2" ROSCA	81,00	-
2" ROSCA	104,00	-
2 1/2" ROSCA	153,00	-
DN 50	-	135,00
DN 65	197,00	163,00
DN 80	243,00	192,00
DN 100	348,00	273,00
DN 150	653,00	439,00
DN 200	1.285,00	660,00
DN 250	2.134,00	1.054,00
DN 300	3.201,00	1.467,00

	TIPO TYPE	PVP €
--	--------------	-------



BRIDAS CON CODO A 90° PARA CONEXIÓN A TUBO FLEXIBLE

BRIDA CODO DN 65 PN 6 CUADRADA	116,00
BRIDA CODO DN 65 PN 10 REDONDA	137,00
BRIDA CODO DN 80	158,00
BRIDA CODO DN 100	188,00
BRIDA CODO DN 150	263,00



PINZA CON BRIDA (RECAMBIO PARA ZOCALOS)

PINZA CON BRIDA DN-65 PN-6 CUADRADA	185,00
PINZA CON BRIDA DN-65 PN10 REDONDA	185,00
PINZA CON BRIDA DN-80	217,00
PINZA CON BRIDA DN-100	274,00
PINZA CON BRIDA DN-150	391,00



INTERRUPTOR DE NIVEL AGUAS FECALES ECOLOGY

INTERRUPTOR ECOLOGY 6 MTS	61,00
INTERRUPTOR ECOLOGY 15 MTS	94,00
INTERRUPTOR ECOLOGY 20 MTS (ATEX)	185,00

ROVER-BE-MARINA AUTOASPIRANTES USOS VARIOS

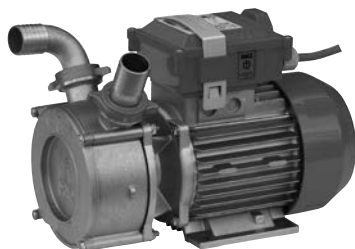

ROVER 20 M CE	134,00
BE 20 M IP 55	178,00
BE 25 M	209,00
ROVER 30 M CE	259,00
BE 30 T	330,00
ROVER 40 M CE	323,00
BE 40 T	391,00
MARINA 12V	371,00
MARINA 24V	371,00

DRILL 20	75,00
KIT BE-25 M CONTADOR	741,00

	TIPO TYPE	CV HP	PVP € BOMBA/Pump
--	--------------	----------	---------------------



COLOMBO - FILTRO PARA VINO

FILTRO DE VINO COLOMBO			424,00
RECAMBIOS FILTRO CKPV 4 (20 Un.)			30,00
RECAMBIOS FILTRO CKPV 8 (20 Un.)			33,00
RECAMBIOS FILTRO CKPV 16 (20 Un.)			33,00

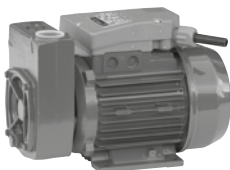

MD - AUTOASPIRANTES PARA GAS-OIL

MD-75 M (IP55)	0,8		303,00
KIT (ASPIRACIÓN-IMPULSIÓN) Ø20			85,00
PISTOLA AUTOMÁTICA 60 lts/min			136,00
CONTADOR GAS-OIL			209,00

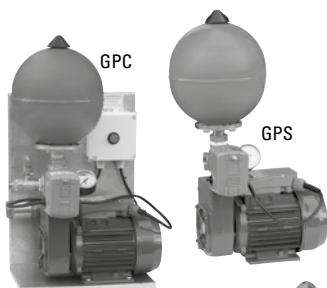

GPS/GPC - GRUPOS DE PRESION PARA GAS-OIL

GPS (SIMPLE)	0,8		435,00
GPC (COMPACTO)	0,8		740,00



BOMBAS DE ARRASTRE MAGNETICO Y VACIADO DE BIDONES

HCM 75			379,00
HCM 100			740,00
HCM 130			911,00
VAC-1000 CAÑA 1000 mm			2.429,00
VAC-1200 CAÑA 1200 mm			2.490,00

	TIPO TYPE	PVP € Monof/Single ph
--	--------------	--------------------------

EVOSTA - CIRCULADORAS DOMESTICAS



BOMBA EVOSTA-2 40-70/130 M (1/2")		208,00
BOMBA EVOSTA-2 40-70/130 M		208,00
BOMBA EVOSTA-2 40-70/180 M		208,00



BOMBA EVOSTA-3 40/130 M		241,00
BOMBA EVOSTA-3 40/180 M		241,00
BOMBA EVOSTA-3 60/130 M		272,00
BOMBA EVOSTA-3 60/180 M		272,00
BOMBA EVOSTA-3 60/180 XM		277,00
BOMBA EVOSTA-3 80/130 M		328,00
BOMBA EVOSTA-3 80/180 M		328,00
BOMBA EVOSTA-3 80/180 XM		332,00

TIPO
TYPE

PVP €
Monof/Single ph

EVOPLUS SMALL - CIRCULADORAS PEQUEÑAS INST.

EVOPLUS SMALL 60/180 XM	632,00
EVOPLUS SMALL 80/180 XM	704,00
EVOPLUS SMALL 110/180 XM	782,00



EVOPLUS SMALL B 40/220.32 M	601,00
EVOPLUS SMALL B 60/220.32 M	663,00
EVOPLUS SMALL B 80/220.32 M	738,00
EVOPLUS SMALL B 110/220.32 M	812,00
EVOPLUS SMALL B 120/220.32 M	1.306,00

EVOPLUS SMALL D 40/220.32 M (DOBLE)	1.411,00
EVOPLUS SMALL D 60/220.32 M (DOBLE)	1.532,00
EVOPLUS SMALL D 80/220.32 M (DOBLE)	1.676,00
EVOPLUS SMALL D 110/220.32 M (DOBLE)	1.828,00
EVOPLUS SMALL D 120/220.32 M (DOBLE)	2.351,00



EVOPLUS SMALL B 60/250.40 M	724,00
EVOPLUS SMALL B 80/250.40 M	796,00
EVOPLUS SMALL B 110/250.40 M	873,00

EVOPLUS SMALL D 60/250.40 M (DOBLE)	1.633,00
EVOPLUS SMALL D 80/250.40 M (DOBLE)	1.778,00
EVOPLUS SMALL D 110/250.40 M (DOBLE)	1.928,00

EVOPLUS B CIRCULADORAS SIMPLES INST. COLECTIVAS

EVOPLUS B 40/220.40 M	1.246,00
EVOPLUS B 60/220.40 M	1.292,00
EVOPLUS B 80/220.40 M	1.336,00
EVOPLUS B 100/220.40 M	1.424,00
EVOPLUS B 120/250.40 M	1.531,00
EVOPLUS B 150/250.40 M	1.899,00
EVOPLUS B 180/250.40 M	2.196,00

EVOPLUS B 40/240.50 M	1.395,00
EVOPLUS B 60/240.50 M	1.633,00
EVOPLUS B 80/240.50 M	1.767,00



EVOPLUS B 100/280.50 M	1.899,00
EVOPLUS B 120/280.50 M	2.046,00
EVOPLUS B 150/280.50 M	2.255,00
EVOPLUS B 180/280.50 M	2.463,00

EVOPLUS B 40/340.65 M	1.752,00
EVOPLUS B 60/340.65 M	2.017,00
EVOPLUS B 80/340.65 M	2.152,00
EVOPLUS B 100/340.65 M	2.255,00
EVOPLUS B 120/340.65 M	2.463,00
EVOPLUS B 150/340.65 M	2.790,00

EVOPLUS B 40/360.80 M	2.108,00
EVOPLUS B 60/360.80 M	2.284,00
EVOPLUS B 80/360.80 M	2.463,00
EVOPLUS B 100/360.80 M	2.729,00
EVOPLUS B 120/360.80 M	3.028,00

EVOPLUS B 40/450.100 M	2.463,00
EVOPLUS B 60/450.100 M	2.672,00
EVOPLUS B 80/450.100 M	2.910,00
EVOPLUS B 100/450.100 M	3.204,00
EVOPLUS B 120/450.100 M	3.590,00

TIPO
TYPE

PVP €
Monof/Single ph

EOPLUS D CIRCULADORAS DOBLES INST. COLECTIVAS



EOPLUS D 40/220.40 M	2.290,00
EOPLUS D 60/220.40 M	2.336,00
EOPLUS D 80/220.40 M	2.373,00
EOPLUS D 100/220.40 M	2.535,00

EOPLUS D 120/250.40 M	2.816,00
EOPLUS D 150/250.40 M	3.419,00
EOPLUS D 180/250.40 M	3.923,00

EOPLUS D 40/240.50 M	2.508,00
EOPLUS D 60/240.50 M	2.937,00
EOPLUS D 80/240.50 M	3.209,00

EOPLUS D 100/280.50 M	3.419,00
EOPLUS D 120/280.50 M	3.686,00
EOPLUS D 150/280.50 M	4.237,00
EOPLUS D 180/280.50 M	4.909,00

EOPLUS D 40/340.65 M	3.180,00
EOPLUS D 60/340.65 M	3.632,00
EOPLUS D 80/340.65 M	3.903,00
EOPLUS D 100/340.65 M	4.147,00
EOPLUS D 120/340.65 M	4.493,00
EOPLUS D 150/340.65 M	5.170,00

EOPLUS D 40/360.80 M	3.911,00
EOPLUS D 60/360.80 M	4.232,00
EOPLUS D 80/360.80 M	4.553,00
EOPLUS D 100/360.80 M	5.029,00
EOPLUS D 120/360.80 M	5.536,00

EOPLUS D 40/450.100 M	4.521,00
EOPLUS D 60/450.100 M	4.881,00
EOPLUS D 80/450.100 M	5.293,00
EOPLUS D 100/450.100 M	5.828,00
EOPLUS D 120/450.100 M	6.553,00



BOMBAS CIRCULADORAS PARA AGUA SANITARIA

VS 8-150 M	259,00
VS 16-150 M	273,00
VS 35-150 M	285,00
VS 65-150 M	295,00



KITS RACORES Y BRIDAS

KIT RACORES 1"	12,50
KIT RACORES 1 1/4"	16,50
KIT RACORES 1" LATON	32,00
KIT BRIDAS DN-32 PN 10	58,00
KIT BRIDAS DN-40 PN 10	62,00
KIT BRIDAS DN-50 PN 10	70,00
KIT BRIDAS DN-65 PN 10	84,00
KIT BRIDAS DN-80 PN 10	89,00

	TIPO TYPE	CV HP	PVP € Monof/Single ph	PVP € Trif/Three ph
--	--------------	----------	--------------------------	------------------------

ALM-ALP - CIRCULADORAS IN-LINE ROTOR SECO



ALM 200	0,08		495,00	436,00
ALP 800	0,5		427,00	381,00
ALM 500	0,33		578,00	523,00
ALP 2000	0,75		583,00	533,00

KL - CIRCULADORAS IN-LINE ROTOR SECO



KLM 40-300	0,33		712,00	643,00
KLP 40-600	0,5		712,00	643,00
KLP 40-900	0,5		712,00	643,00
KLP 40-1200	0,75		753,00	690,00
KLP 40-1600	1		-	749,00
KLP 40-1800	1,15		-	749,00
KLM 50-300	0,33		1.062,00	981,00
KLM 50-600	0,33		1.062,00	981,00
KLP 50-900	1		1.085,00	1.123,00
KLP 50-1200	1		1.085,00	1.123,00
KLP 50-1600	1,5		-	1.180,00
KLP 50-2000	2,5		-	1.339,00
KLM 65-300	0,33		-	990,00
KLM 65-600	0,5		-	990,00
KLP 65-900	1,5		-	1.182,00
KLP 65-1200	1,5		-	1.182,00
KLP 65-1600	2,2		-	1.227,00
KLP 65-2000	2,7		-	1.339,00
KLM 80-300	0,33		-	1.004,00
KLM 80-600	1		-	1.146,00
KLP 80-900	2,5		-	1.444,00
KLP 80-1200	2,5		-	1.444,00
KLP 80-1600	3,5		-	1.728,00
KLP 80-2000	5		-	2.002,00

DKL - CIRCULADORAS DOBLES IN-LINE ROTOR SECO



DKLM 40-300	2 x 0,33		1.381,00	1.263,00
DKLP 40-600	2 x 0,5		1.381,00	1.263,00
DKLP 40-900	2 x 0,5		1.381,00	1.263,00
DKLP 40-1200	2 x 0,75		1.438,00	1.306,00
DKLP 40-1600	2 x 1		-	1.452,00
DKLP 40-1800	2 x 1,15		-	1.452,00
DKLM 50-300	2 x 0,33		2.018,00	1.866,00
DKLM 50-600	2 x 0,33		2.018,00	1.866,00
DKLP 50-900	2 x 1		2.054,00	2.187,00
DKLP 50-1200	2 x 1		2.054,00	2.187,00
DKLP 50-1600	2 x 1,5		-	2.194,00
DKLP 50-2000	2 x 2,5		-	2.489,00
DKLM 65-300	2 x 0,33		-	1.900,00
DKLM 65-600	2 x 0,5		-	1.900,00
DKLP 65-900	2 x 1,5		-	2.293,00
DKLP 65-1200	2 x 1,5		-	2.293,00
DKLP 65-1600	2 x 2,2		-	2.290,00
DKLP 65-2000	2 x 2,7		-	2.597,00
DKLM 80-300	2 x 0,33		-	1.921,00
DKLM 80-600	2 x 1		-	2.189,00
DKLP 80-900	2 x 2,5		-	2.775,00
DKLP 80-1200	2 x 2,5		-	2.775,00
DKLP 80-1600	2 x 3,5		-	3.318,00
DKLP 80-2000	2 x 5		-	3.843,00

	TIPO TYPE	CV HP	PVP € Motor IE-3
--	--------------	----------	---------------------

CM CIRCULADORAS IN-LINE A 1,450 RPM ROTOR SECO

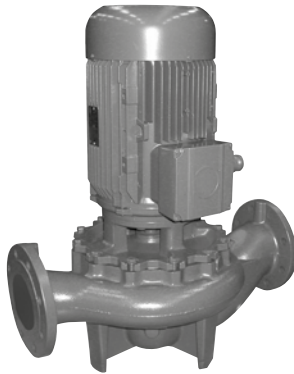

1.450 R.P.M.

PARA BOMBAS GEMELAS
CONSULTEN CON NUESTRO
DEPARTAMENTO COMERCIAL.

CM 40-440 T	1	1.035,00
CM 40-540 T	1	1.035,00
CM 40-670 T	1	1.068,00
CM 40-870 T	1	1.068,00
CM 40-1300 T	1	1.645,00
CM 40-1450 T	1,3	1.855,00
CM 50-510 T	1	1.102,00
CM 50-630 T	1	1.139,00
CM 50-780 T	1	1.139,00
CM 50-1000 T	1	1.139,00
CM 50-1270 T	1,5	2.147,00
CM 50-1420 T	1,5	2.147,00
CM-G 65-420 T	0,33	1.097,00
CM-G 65-540 T	0,5	1.124,00
CM-G 65-660 T	0,75	1.155,00
CM-G 65-760 T	0,75	1.182,00
CM-G 65-920 T	1	1.462,00
CM-G 65-1080 T	1,5	1.521,00
CM-G 65-1200 T	2	1.643,00
CM-G 65-1530 T	3	1.841,00
CM-G 65-1680 T	4	1.873,00
CM-G 65-2380 T	5,5	2.012,00
CM-G 80-550 T	0,75	1.449,00
CM-G 80-650 T	1	1.750,00
CM-G 80-740 T	1,5	1.808,00
CM-G 80-890 T	2	1.930,00
CM-G 80-1050 T	3	2.126,00
CM-G 80-1530 T	4	2.161,00
CM-G 80-1700 T	5,5	2.303,00
CM-G 80-2410 T	7,5	3.070,00
CM-G 80-2700 T	10	3.860,00
CM-G 80-3420 T	15	4.373,00
CM-G 100-510 T	1	2.085,00
CM-G 100-650 T	1,5	2.145,00
CM-G 100-660 T	2	2.265,00
CM-G 100-865 T	3	2.461,00
CM-G 100-1020 T	4	2.494,00
CM-G 100-1320 T	5,5	2.639,00
CM-G 100-1650 T	7,5	3.406,00
CM-G 100-2050 T	10	4.209,00
CM-G 100-2550 T	15	4.720,00
CM-G 100-3290 T	20	5.399,00
CM-G 100-3680 T	25	5.917,00
CM-G 100-4100 T	30	6.943,00
CM-G 125-1075 T	5,5	3.218,00
CM-G 125-1270 T	7,5	3.988,00
CM-G 125-1560 T	10	4.814,00
CM-G 125-2100 T	15	5.329,00
CM-G 125-2550 T	20	6.005,00
CM-G 125-3200 T	25	6.520,00
CM-G 125-3600 T	30	7.544,00
CM-G 125-4022 T	40	9.175,00
CM-G 150-955 T	7,5	4.549,00
CM-G 150-1322 T	10	5.553,00
CM-G 150-1600 T	15	6.202,00
CM-G 150-1950 T	20	6.715,00
CM-G 150-2200 T	25	7.398,00
CM-G 150-2405 T	30	7.909,00

	TIPO TYPE	CV HP	PVP € Motor IE-3
--	--------------	----------	---------------------

CP - CIRCULADORAS IN-LINE A 2,900 RPM ROTOR SECO



2.900 R.P.M.

PARA BOMBAS GEMELAS
CONSULTEN CON NUESTRO
DEPARTAMENTO COMERCIAL.

CP 40-1900 T	1	1.130,00
CP 40-2300 T	1,5	1.148,00
CP 40-2700 T	2	1.172,00
CP 40-3500 T	3	1.259,00
CP 40-3800 T	4	2.034,00
CP 40-4700 T	5,5	2.299,00
CP 40-5500 T	7,5	2.670,00
CP 40-6200 T	10	3.306,00
CP 50-2200 T	1,5	1.240,00
CP 50-2600 T	2	1.312,00
CP 50-3100 T	3	1.363,00
CP 50-4100 T	5,5	1.541,00
CP 50-4600 T	7,5	2.925,00
CP 50-5100 T	10	3.452,00
CP 50-5650 T	10	3.452,00
CP-G 65-1470 T	2	1.614,00
CP-G 65-1900 T	3	1.767,00
CP-G 65-2280 T	4	1.924,00
CP-G 65-2640 T	5,5	2.108,00
CP-G 65-3400 T	7,5	2.261,00
CP-G 65-4100 T	10	2.730,00
CP-G 65-4700 T	15	3.689,00
CP-G 65-5500 T	20	4.559,00
CP-G 65-6150 T	25	4.875,00
CP-G 65-7350 T	30	5.347,00
CP-G 65-9250 T	40	6.132,00
CP-G 80-1400 T	3	1.924,00
CP-G 80-1700 T	4	2.080,00
CP-G 80-2050 T	5,5	2.229,00
CP-G 80-2400 T	7,5	2.611,00
CP-G 80-2770 T	10	3.176,00
CP-G 80-3250 T	15	3.756,00
CP-G 80-4000 T	20	4.714,00
CP-G 80-5150 T	25	5.588,00
CP-G 80-5650 T	30	5.902,00
CP-G 80-6850 T	40	6.551,00
CP-G 80-8600 T	50	8.436,00
CP-G 80-9600 T	60	10.152,00
CP-G 80-10200 T	75	12.247,00
CP-G 100-1600 T	5,5	2.814,00
CP-G 100-1950 T	7,5	3.198,00
CP-G 100-2350 T	10	3.793,00
CP-G 100-2400 T	15	4.370,00
CP-G 100-3050 T	20	4.998,00
CP-G 100-3550 T	25	5.874,00
CP-G 100-3850 T	30	6.189,00
CP-G 100-4800 T	40	7.077,00
CP-G 100-5600 T	50	8.508,00
CP-G 100-6300 T	60	10.218,00
CP-G 100-8300 T	75	12.316,00
CP-G 125-4750 T	50	9.555,00
CP-G 125-5300 T	60	11.269,00
CP-G 125-5800 T	75	13.365,00

TIPO
TYPE

PVP €

[e]MOTION - VARIADOR DE FRECUENCIA



VARIADOR [e]MOTION MT2-11	566,00
VARIADOR [e]MOTION TT3-11	815,00
VARIADOR [e]MOTION TT3-30 (UP TO 20HP)	1.600,00

SOPORTE PARED VARIADOR [e]MOTION (MT2-11, TT3-11)	79,00
SOPORTE PARED VARIADOR [e]MOTION (TT3-30)	197,00
TRANS. PRESIÓN 0-10 BAR 4-20mA (2 m CABLE)	99,00
TRANS. PRESIÓN 0-25 BAR 4-20mA (SIN CABLE)	99,00
TRANS. PRESIÓN 0-40 BAR 4-20mA (SIN CABLE)	147,00



PRESCONTROL-MASCONTROL-CONTROLPRESS

PRESCONTROL CON CABLES	121,00
MASCONTROL	194,00
CONTROLPRESS REGULABLE	291,00
SACIPRESS CON CABLES	76,00
AUTOPRESS CON CABLES	76,00
KIT CONECTOR 3 PIEZAS	6,00

ACCESORIOS



PRESOST FSG-2	20,50
PRESOST FYG-22	34,00
PRESOST FYG-32	39,00
PRESOST FSG-2 / M4	63,00
PRESOST FXG-2 (XMXA06L2135)	63,00
PRESOST FXG-4 (XMXA12L2135)	65,00
TELEM 6	27,80
TELEM 12	31,00
TELEM 25	90,00
RACOR 5 VIAS	12,00
MANOMETRO	6,70
MANOMETRO GLICERINA	16,00
INTERRUPTOR SACI 2 (3 mts cable)	20,00
INTERRUPTOR SACI 2 (5 mts cable)	25,00
INTERRUPTOR SACI 2 (10 mts cable)	34,00
KIT EMPALME TERMORETRACTIL	11,30
KIT EMPALME RESINA EC 04 (CM 0)	27,00
KIT EMPALME RESINA EC 104 (CM 1)	42,00
TAPA POZO POLIESTER 1 1/4" DIAM 210	32,00
TAPA POZO GALVANIZADA 1 1/4" DIAM 210	53,00
TAPA POZO AISI-304 1 1/4" DIAM 205	71,00
ROLLO 100 MTS CUERDA BLANCA DIAM 10 MM	132,00
ROLLO 300 MTS CUERDA BLANCA DIAM 10 MM	291,00
INYECTOR DE AIRE MINI	96,00
INYECTOR DE AIRE MIDI	173,00
INYECTOR DE AIRE MAXI	266,00

TIPO
TYPE

PVP €



CAUDALÍMETROS SUELTOS ECO F300

CAUDALIMETRO 1-1/2' -50 MM (3-21 M3/H) F30050M	192,00
CAUDALIMETRO 2' - 63 MM (6-28 M3/H) F30063M	203,00
CAUDALIMETRO 2-1/2' -75 MM (9-42 M3/H) F30075M	232,00
CAUDALIMETRO 3'-90 MM (12-51 M3/H) F30090M	261,00
CAUDALIMETRO 4'-110 MM (36-108 M3/H) F30110M	300,00
CAUDALIMETRO 6'-160 MM (54-192 M3/H) F30160M	485,00
CAUDALIMETRO 8'-200 MM (90-306 M3/H) F30200M	539,00

PAG. CAT.
CAT. PAGE

TIPO
TYPE

PVP €



FILTROS DE CARTUCHO

FILTRO 3 PIEZAS 10" LARGO 1"	36,00
CART. PP. BOBINADO 50 MICRAS 1"	9,00
CART. PP. BOBINADO 9" 3/4-1 MICRA	11,80
CART. PP. BOBINADO 9" 3/4-5 MICRA	10,50
CART. MALLA LAVABLE 60 MICRAS 1"	21,00
CART. CARBON ACTIVO 60 MICRAS 1"	19,00
CART. POLIFOSFATOS 1"	35,00

	TIPO TYPE	PRESIÓN PRESSURE	PVP €
--	--------------	---------------------	-------

AIRMAX - DEPOSITOS DE MEMBRANA FIJA



AIRMAX 3 Lts EXP	10 Bar	31,00
AIRMAX 8 Lts EXP	10 Bar	42,00
AIRMAX 12 Lts EXP	10 Bar	48,00
AIRMAX 18 Lts EXP	10 Bar	54,00
AIRMAX 24 Lts EXP	10 Bar	57,00
AIRMAX 40 Lts EXP	10 Bar	79,00
AIRMAX 60 Lts EXP	10 Bar	128,00
AIRMAX 60 Lts VER	10 Bar	136,00
AIRMAX 80 Lts VER	10 Bar	182,00
AIRMAX 100 Lts VER	10 Bar	232,00
AIRMAX 160 Lts VER	10 Bar	366,00
AIRMAX 200 Lts VER	10 Bar	537,00
AIRMAX 300 Lts VER	10 Bar	728,00
AIRMAX 450 Lts VER	10 Bar	1.110,00
AIRMAX 24 Lts HOR	10 Bar	70,00
AIRMAX 60 Lts HOR	10 Bar	140,00
AIRMAX 80 Lts HOR	10 Bar	183,00
AIRMAX 100 Lts HOR	10 Bar	239,00

	TIPO TYPE	PVP € 10 Bar	PVP € 16 Bar
--	--------------	-----------------	-----------------

EVO - DEPOSITOS DE MEMBRANA RECAMBIABLE



EVO 8 LTS EXPANSOR	36,00	-
EVO 12 LTS EXPANSOR	39,00	-
EVO 19 LTS EXPANSOR	41,00	-
EVO 24 LTS EXPANSOR	37,00	-
EVO 35 LTS EXPANSOR	85,00	-
EVO 50 LTS EXPANSOR	102,00	161,00
EVO 50 LTS VERTICAL	102,00	161,00
EVO 80 LTS VERTICAL	199,00	-
EVO 100 LTS VERTICAL	215,00	325,00
EVO 150 LTS VERTICAL	314,00	440,00
EVO 200 LTS VERTICAL	409,00	638,00
EVO 300 LTS VERTICAL	455,00	696,00
EVO 500 LTS VERTICAL	742,00	1.092,00
EVO 750 LTS VERTICAL	1.161,00	1.475,00
EVO 1000 LTS VERTICAL	1.823,00	2.271,00
EVO 1500 LTS VERTICAL	2.540,00	3.245,00
EVO 24 LTS HORIZONTAL	63,00	-
EVO 50 LTS HORIZONTAL	110,00	-
EVO 80 LTS HORIZONTAL	199,00	-
EVO 100 LTS HORIZONTAL	226,00	-

	TIPO TYPE	PVP €
--	--------------	-------

[e]MOTION - VARIADORES SUELTOS DE FRECUENCIA



VARIADOR [e]MOTION MT2-11	566,00
VARIADOR [e]MOTION TT3-11	815,00
VARIADOR [e]MOTION TT3-30 (UP TO 20HP)	1.600,00

SOPORTE PARED VARIADOR [e]MOTION (MT2-11, TT3-11)	79,00
SOPORTE PARED VARIADOR [e]MOTION (TT3-30)	197,00
TRANSDUCTOR DE PRESIÓN 0-10 BAR 4-20mA (2 m CABLE)	99,00
TRANSDUCTOR DE PRESIÓN 0-25 BAR 4-20mA (SIN CABLE)	99,00
TRANSDUCTOR DE PRESIÓN 0-40 BAR 4-20mA (SIN CABLE)	147,00

	TIPO TYPE	PVP € 1 BOMBA	PVP € 2 BOMBAS
--	--------------	------------------	-------------------

[e]NOX - EQUIPOS DE PRESIÓN 1 Y 2 BOMBAS



EQUIPO [e]NOX 306 (MT2)*	1.550,00	3.083,00
EQUIPO [e]NOX 310 (TT3)*	2.038,00	3.823,00
EQUIPO [e]NOX 407 (TT3)*	1.948,00	3.777,00

*Variador de frecuencia + motores de imanes permanentes

*Variable frequency drive + permanent magnet motors

[e]MOTION - EQUIPOS DE PRESIÓN 1 Y 2 BOMBAS



[e]motion SIGMA 105 (MT2)	1.080,00	2.080,00
[e]motion SIGMA 205 (MT2)	1.175,00	2.270,00
[e]motion SIGMA 303 (MT2)	1.211,00	2.350,00
[e]motion SIGMA 304 (MT2)	1.225,00	2.371,00
[e]motion SIGMA 305 (MT2)	1.235,00	2.407,00
[e]motion SIGMA 306 (MT2)	1.271,00	2.452,00
[e]motion SIGMA 307 (MT2)	1.319,00	2.481,00
[e]motion SIGMA 403 (MT2)	1.221,00	2.455,00
[e]motion SIGMA 404 (MT2)	1.321,00	2.509,00

[e]motion V-NOX 303 (MT2)	1.262,00	2.411,00
[e]motion V-NOX 304 (MT2)	1.277,00	2.440,00
[e]motion V-NOX 304 (TT3) ESPECIAL	1.367,00	2.620,00
[e]motion V-NOX 305 (MT2)	1.291,00	2.468,00
[e]motion V-NOX 305 (TT3) ESPECIAL	1.381,00	2.648,00
[e]motion V-NOX 306 (MT2)	1.325,00	2.537,00
[e]motion V-NOX 306 (TT3) ESPECIAL	1.415,00	2.717,00
[e]motion V-NOX 307 (MT2)	1.343,00	2.572,00
[e]motion V-NOX 307 (TT3) ESPECIAL	1.433,00	2.752,00
[e]motion V-NOX 308 (TT3)	1.619,00	3.119,00
[e]motion V-NOX 309 (TT3)	1.639,00	3.231,00
[e]motion V-NOX 310 (TT3)	1.751,00	3.304,00

[e]motion V-NOX 403 (MT2)	1.274,00	2.497,00
[e]motion V-NOX 404 (MT2)	1.311,00	2.587,00
[e]motion V-NOX 405 (TT3)	1.592,00	3.059,00
[e]motion V-NOX 406 (TT3)	1.693,00	3.089,00
[e]motion V-NOX 407 (TT3)	1.734,00	3.187,00

	TIPO TYPE	PVP € 1 BOMBA	PVP € 2 BOMBAS
--	--------------	------------------	-------------------

[e]MOTION - EQUIPOS DE PRESIÓN 1 Y 2 BOMBAS



[e]motion XV-F 5-8 (MT2)	1.568,00	3.049,00
[e]motion XV-F 5-10 (MT2)	1.652,00	3.218,00
[e]motion XV-F 5-14 (MT2)	1.773,00	3.459,00
[e]motion XV-F 5-16 (MT2)	1.895,00	3.623,00
[e]motion XV-F 5-20 (TT3)	2.168,00	4.170,00
[e]motion XV-F 5-29 (TT3)	2.530,00	4.954,00
[e]motion XV-F 5-36 (TT3-30)	3.784,00	7.426,00
[e]motion XV-F 10-6 (MT2)	1.833,00	3.577,00
[e]motion XV-F 10-9 (TT3)	2.114,00	4.140,00
[e]motion XV-F 10-10 (TT3)	2.296,00	4.423,00
[e]motion XV-F 10-12 (TT3)	2.393,00	4.617,00
[e]motion XV-F 10-16 (TT3-30)	3.662,00	7.086,00
[e]motion XV-F 10-22 (TT3-30)	4.111,00	8.103,00
[e]motion XV-F 15-5 (TT3)	2.227,00	4.539,00
[e]motion XV-F 15-7 (TT3-30)	3.508,00	6.973,00
[e]motion XV-F 15-9 (TT3-30)	3.758,00	7.368,00
[e]motion XV-F 15-14 (TT3-30)	4.831,00	9.558,00
[e]motion XV-F 15-17 (TT3-30)	5.106,00	10.177,00
[e]motion XV-F 20-5 (TT3-30)	3.375,00	6.706,00
[e]motion XV-F 20-7 (TT3-30)	3.664,00	7.201,00
[e]motion XV-F 20-10 (TT3-30)	4.349,00	8.647,00
[e]motion XV-F 20-14 (TT3-30)	4.872,00	9.813,00
[e]motion XV-F 32-3 (TT3-30)	4.026,00	8.173,00
[e]motion XV-F 32-4 (TT3-30)	4.234,00	8.589,00
[e]motion XV-F 32-6 (TT3-30)	5.315,00	10.469,00
[e]motion XV-F 32-8 (TT3-30)	5.691,00	11.220,00
[e]motion XV-F 45-2 (TT3-30)	4.228,00	8.629,00
[e]motion XV-F 45-3 (TT3-30)	5.017,00	10.209,00
[e]motion XV-F 45-4 (TT3-30)	5.335,00	10.723,00
[e]motion XV-F 64-2 (TT3-30)	4.978,00	10.172,00
[e]motion XV-F 64-3-1 (TT3-30)	5.299,00	10.783,00
[e]motion XV-F 90-2-2 (TT3-30)	5.133,00	10.576,00
[e]motion XV-F 90-2 (TT3-30)	5.285,00	10.880,00
[e]motion XV-F 120-1 (TT3-30)	8.217,00	16.621,00
[e]motion XV-F 150-1-1 (TT3-30)	8.242,00	16.670,00
[e]motion XV-F 150-1 (TT3-30)	8.465,00	17.116,00

	TIPO TYPE	PVP € 3 BOMBAS	PVP € 4 BOMBAS
--	--------------	-------------------	-------------------

[e]NOX - EQUIPOS DE PRESIÓN 3 Y 4 BOMBAS

EQUIPO [e]NOX 306 (MT2)*	4.595,00	6.301,00
EQUIPO [e]NOX 310 (TT3)*	5.535,00	7.568,00
EQUIPO [e]NOX 407 (TT3)*	6.065,00	7.705,00

*Variador de frecuencia + motores de imanes permanentes

*Variable frequency drive + permanent magnet motors



[e]MOTION - EQUIPOS DE PRESIÓN 3 Y 4 BOMBAS

[e]motion SIGMA 105 (MT2)	3.244,00	4.192,00
[e]motion SIGMA 205 (MT2)	3.501,00	4.534,00
[e]motion SIGMA 303 (MT2)	3.584,00	4.808,00
[e]motion SIGMA 304 (MT2)	3.615,00	4.851,00
[e]motion SIGMA 305 (MT2)	3.669,00	4.922,00
[e]motion SIGMA 306 (MT2)	3.789,00	5.081,00
[e]motion SIGMA 307 (MT2)	3.831,00	5.138,00
[e]motion SIGMA 403 (MT2)	4.136,00	5.025,00
[e]motion SIGMA 404 (MT2)	4.269,00	5.202,00



[e]motion V-NOX 303 (MT2)	3.693,00	4.918,00
[e]motion V-NOX 304 (MT2)	3.736,00	4.948,00
[e]motion V-NOX 304 (TT3) ESPECIAL	4.006,00	5.308,00
[e]motion V-NOX 305 (MT2)	3.778,00	5.034,00
[e]motion V-NOX 305 (TT3) ESPECIAL	4.048,00	5.394,00
[e]motion V-NOX 306 (MT2)	3.881,00	5.196,00
[e]motion V-NOX 306 (TT3) ESPECIAL	4.151,00	5.556,00
[e]motion V-NOX 307 (MT2)	3.932,00	5.255,00
[e]motion V-NOX 307 (TT3) ESPECIAL	4.202,00	5.615,00
[e]motion V-NOX 308 (TT3)	4.758,00	6.163,00
[e]motion V-NOX 309 (TT3)	4.762,00	6.223,00
[e]motion V-NOX 310 (TT3)	4.859,00	6.395,00

[e]motion V-NOX 403 (MT2)	4.124,00	5.137,00
[e]motion V-NOX 404 (MT2)	4.259,00	5.317,00
[e]motion V-NOX 405 (TT3)	4.966,00	6.260,00
[e]motion V-NOX 406 (TT3)	5.012,00	6.321,00
[e]motion V-NOX 407 (TT3)	5.159,00	6.517,00

TIPO
TYPE

PVP €
3 BOMBA

PVP €
4 BOMBAS

[e]MOTION - EQUIPOS DE PRESIÓN 3 Y 4 BOMBAS



[e]motion XV-F 5-8 (MT2)	4.590,00	5.932,00
[e]motion XV-F 5-10 (MT2)	4.844,00	6.271,00
[e]motion XV-F 5-14 (MT2)	5.205,00	6.753,00
[e]motion XV-F 5-16 (MT2)	5.296,00	6.884,00
[e]motion XV-F 5-20 (TT3)	6.118,00	7.980,00
[e]motion XV-F 5-29 (TT3)	7.336,00	9.632,00
[e]motion XV-F 5-36 (TT3-30)	10.950,00	14.971,00

[e]motion XV-F 10-6 (MT2)	5.383,00	7.180,00
[e]motion XV-F 10-9 (TT3)	6.228,00	8.306,00
[e]motion XV-F 10-10 (TT3)	6.498,00	8.678,00
[e]motion XV-F 10-12 (TT3)	6.788,00	9.065,00
[e]motion XV-F 10-16 (TT3-30)	10.385,00	14.403,00
[e]motion XV-F 10-22 (TT3-30)	11.332,00	15.724,00

[e]motion XV-F 15-5 (TT3)	6.676,00	9.244,00
[e]motion XV-F 15-7 (TT3-30)	10.417,00	14.284,00
[e]motion XV-F 15-9 (TT3-30)	10.823,00	14.833,00
[e]motion XV-F 15-14 (TT3-30)	14.297,00	19.335,00
[e]motion XV-F 15-17 (TT3-30)	15.152,00	20.207,00

[e]motion XV-F 20-5 (TT3-30)	10.083,00	13.751,00
[e]motion XV-F 20-7 (TT3-30)	10.649,00	14.522,00
[e]motion XV-F 20-10 (TT3-30)	12.861,00	17.057,00
[e]motion XV-F 20-14 (TT3-30)	14.670,00	19.480,00



[e]motion XV-F 32-3 (TT3-30)	12.240,00	16.198,00
[e]motion XV-F 32-4 (TT3-30)	12.865,00	17.032,00
[e]motion XV-F 32-6 (TT3-30)	15.495,00	20.547,00
[e]motion XV-F 32-8 (TT3-30)	16.621,00	22.019,00

[e]motion XV-F 45-2 (TT3-30)	12.964,00	17.250,00
[e]motion XV-F 45-3 (TT3-30)	15.337,00	20.417,00
[e]motion XV-F 45-4 (TT3-30)	15.889,00	21.198,00

[e]motion XV-F 64-2 (TT3-30)	15.370,00	20.688,00
[e]motion XV-F 64-3-1 (TT3-30)	16.332,00	21.911,00

[e]motion XV-F 90-2-2 (TT3-30)	16.059,00	21.305,00
[e]motion XV-F 90-2 (TT3-30)	16.472,00	21.885,00

[e]motion XV-F 120-1 (TT3-30)	24.894,00	33.081,00
-------------------------------	------------------	------------------

[e]motion XV-F 150-1-1 (TT3-30)	24.968,00	33.179,00
[e]motion XV-F 150-1 (TT3-30)	25.637,00	34.042,00



EQUIPOS DE PRESIÓN DE 1 BOMBA

SIGMA

MODELO EQUIPO 1 Bomba / 1 Pump	P.V.P. CUADRO NORMAL	P.V.P. CUADRO VARIO SYSTEM
EP 1 x SIGMA 102M	764,00	-
EP 1 x SIGMA 103M	770,00	-
EP 1 x SIGMA 104M	779,00	-
EP 1 x SIGMA 105M	797,00	-
EP 1 x SIGMA 202M	847,00	-
EP 1 x SIGMA 203M	842,00	-
EP 1 x SIGMA 204M	872,00	-
EP 1 x SIGMA 205M	889,00	-
EP 1 x SIGMA 303M	1.015,00	-
EP 1 x SIGMA 304M	1.027,00	-
EP 1 x SIGMA 305M	1.044,00	-
EP 1 x SIGMA 403M	1.031,00	-
EP 1 x SIGMA 105	799,00	-
EP 1 x SIGMA 205	881,00	-
EP 1 x SIGMA 303	983,00	2.163,00
EP 1 x SIGMA 304	993,00	2.173,00
EP 1 x SIGMA 305	1.012,00	2.190,00
EP 1 x SIGMA 306	1.049,00	2.290,00
EP 1 x SIGMA 307	1.114,00	2.325,00
EP 1 x SIGMA 403	1.002,00	2.182,00
EP 1 x SIGMA 404	1.095,00	2.338,00

V-NOX

MODELO EQUIPO 1 Bomba / 1 Pump	P.V.P. CUADRO NORMAL	P.V.P. CUADRO VARIO SYSTEM
EP 1 x V-NOX 303 MONOF	1.039,00	-
EP 1 x V-NOX 304 MONOF	1.051,00	-
EP 1 x V-NOX 305 MONOF	1.068,00	-
EP 1 x V-NOX 403 MONOF	1.090,00	-
EP 1 x V-NOX 303	1.007,00	2.241,00
EP 1 x V-NOX 304	1.014,00	2.248,00
EP 1 x V-NOX 305	1.036,00	2.268,00
EP 1 x V-NOX 306	1.073,00	2.369,00
EP 1 x V-NOX 307	1.087,00	2.352,00
EP 1 x V-NOX 308	1.209,00	2.573,00
EP 1 x V-NOX 309	1.230,00	2.593,00
EP 1 x V-NOX 310	1.275,00	2.811,00
EP 1 x V-NOX 403	1.045,00	2.279,00
EP 1 x V-NOX 404	1.087,00	2.384,00
EP 1 x V-NOX 405	1.217,00	2.613,00
EP 1 x V-NOX 406	1.233,00	2.627,00
EP 1 x V-NOX 407	1.285,00	2.850,00

- En el momento de pasar pedido deben especificar tensión de trabajo.
- En caso de pasar pedido de equipo con variador de frecuencia, la denominación de éste debe incluir el término VARIO, p.ej.: EP 1 x V-NOX 305 (equipo con cuadro normal) VARIO 1 x V-NOX 305 (equipo con cuadro con variador de frecuencia).
- Recuerden que equipos con cuadro normal, falta incluir el depósito de membrana o el depósito galvanizado con sus correspondientes inyectores (1 por bomba). Pueden seleccionar el depósito idóneo en el Catálogo General. Los equipos con variador de frecuencia ya incorporan un pequeño depósito para su óptimo funcionamiento, por lo cual no es necesario proveer ningún otro depósito.

EQUIPOS DE PRESIÓN DE 1 BOMBA

XV-F 5-45

MODELO EQUIPO 1 Bomba / 1 Pump	P.V.P. CUADRO NORMAL	P.V.P. CUADRO VARIO SYSTEM
EP 1 x XV-F 5-8	1.233,00	2.387,00
EP 1 x XV-F 5-10	1.313,00	2.640,00
EP 1 x XV-F 5-14	1.418,00	2.781,00
EP 1 x XV-F 5-16	1.457,00	2.820,00
EP 1 x XV-F 5-20	1.688,00	3.109,00*
EP 1 x XV-F 5-29	2.176,00	3.782,00*
EP 1 x XV-F 5-36	2.900,00	4.338,00*
EP 1 x XV-F 10-6	1.470,00	2.867,00
EP 1 x XV-F 10-9	1.712,00	3.180,00
EP 1 x XV-F 10-10	1.854,00	3.490,00
EP 1 x XV-F 10-12	1.944,00	3.532,00*
EP 1 x XV-F 10-16	2.691,00	4.128,00*
EP 1 x XV-F 10-22	3.241,00	5.413,00*
EP 1 x XV-F 15-5	1.863,00	3.531,00
EP 1 x XV-F 15-7	2.572,00	4.066,00
EP 1 x XV-F 15-9	2.718,00	4.588,00*
EP 1 x XV-F 15-14	3.968,00	6.063,00*
EP 1 x XV-F 15-17	4.368,00	6.890,00*
EP 1 x XV-F 20-5	2.653,00	4.307,00
EP 1 x XV-F 20-7	2.868,00	4.894,00
EP 1 x XV-F 20-10	3.697,00	5.967,00*
EP 1 x XV-F 20-14	4.498,00	7.283,00*
EP 1 x XV-F 20-17	4.980,00	8.272,00*
EP 1 x XV-F 32-3	3.302,00	4.955,00
EP 1 x XV-F 32-4	3.522,00	5.585,00
EP 1 x XV-F 32-6	4.612,00	6.933,00
EP 1 x XV-F 32-8	5.197,00	7.929,00*
EP 1 x XV-F 32-10	5.687,00	8.979,00*
EP 1 x XV-F 32-12	6.523,00	10.352,00*
EP 1 x XV-F 32-14	7.864,00	12.225,00*
EP 1 x XV-F 45-2	3.514,00	5.697,00
EP 1 x XV-F 45-3	4.417,00	6.891,00
EP 1 x XV-F 45-4	4.790,00	7.691,00
EP 1 x XV-F 45-5	5.218,00	8.679,00*
EP 1 x XV-F 45-6	6.011,00	10.107,00*
EP 1 x XV-F 45-9-2	9.091,00	13.399,00*
EP 1 x XV-F 45-10	9.613,00	14.560,00*
EP 1 x XV-F 45-13-2	10.858,00	16.684,00*

XV-F 64-150

MODELO EQUIPO 1 Bomba / 1 Pump	P.V.P. CUADRO NORMAL	P.V.P. CUADRO VARIO SYSTEM
EP 1 x XV-F 64-2	4.375,00	6.852,00
EP 1 x XV-F 64-3-1	4.856,00	7.794,00
EP 1 x XV-F 64-4-2	5.304,00	8.765,00
EP 1 x XV-F 64-4	5.899,00	9.898,00*
EP 1 x XV-F 64-6-2	7.467,00	11.775,00*
EP 1 x XV-F 64-7-1	10.173,00	15.120,00*
EP 1 x XV-F 64-8-1	11.100,00	17.140,00*
EP 1 x XV-F 90-2-2	4.530,00	7.006,00
EP 1 x XV-F 90-2	4.842,00	7.780,00
EP 1 x XV-F 90-3-2	5.321,00	8.818,00
EP 1 x XV-F 90-3	6.016,00	10.015,00
EP 1 x XV-F 90-4	7.451,00	11.761,00*
EP 1 x XV-F 90-5	10.263,00	15.210,00*
EP 1 x XV-F 90-6	11.185,00	17.224,00*
EP 1 x XV-F 120-1	7.564,00	9.876,00
EP 1 x XV-F 120-2-1	9.080,00	12.414,00
EP 1 x XV-F 120-2	9.642,00	13.513,00
EP 1 x XV-F 120-3	11.730,00	16.065,00
EP 1 x XV-F 120-4-1	12.883,00	17.857,00*
EP 1 x XV-F 120-5-1	14.355,00	20.335,00*
EP 1 x XV-F 120-6-1	17.828,00	23.497,00*
EP 1 x XV-F 120-7	23.810,00	30.337,00*
EP 1 x XV-F 150-1-1	7.589,00	9.901,00
EP 1 x XV-F 150-1	7.970,00	10.745,00
EP 1 x XV-F 150-2-1	9.578,00	13.449,00
EP 1 x XV-F 150-3-2	11.820,00	16.155,00
EP 1 x XV-F 150-3	12.188,00	17.163,00
EP 1 x XV-F 150-4-1	13.656,00	19.687,00*
EP 1 x XV-F 150-5-2	17.207,00	22.876,00*
EP 1 x XV-F 150-6	23.276,00	29.803,00*

***LOS PRECIOS CON ASTERISCO INDICAN QUE NO SE INCLUYE EL ACUMULADOR**

***THE PRICES WITH ASTERISK INDICATE THAT THE PRESSURE VESSEL IS NOT INCLUDED**

* EL P.V.P. DE LOS EQUIPOS REFLEJADOS CORRESPONDE A TENSIÓN DE TRABAJO TRIF.-400V. PARA OTRAS TENSIONES: MONOFÁSICA O TRIF.-230V ROGAMOS CONSULTEN SUPLEMENTOS.



EQUIPOS DE PRESIÓN DE 2 BOMBAS

SIGMA

MODELO EQUIPO 2 Bombas / 2 Pumps	P.V.P. CUADRO NORMAL	P.V.P. CUADRO VARIO SYSTEM
EP 2 x SIGMA 102M	1.424,00	-
EP 2 x SIGMA 103M	1.437,00	-
EP 2 x SIGMA 104M	1.454,00	-
EP 2 x SIGMA 105M	1.490,00	-
EP 2 x SIGMA 202M	1.591,00	-
EP 2 x SIGMA 203M	1.582,00	-
EP 2 x SIGMA 204M	1.642,00	-
EP 2 x SIGMA 205M	1.674,00	-
EP 2 x SIGMA 303M	1.912,00	-
EP 2 x SIGMA 304M	1.936,00	-
EP 2 x SIGMA 305M	1.969,00	-
EP 2 x SIGMA 403M	1.967,00	-
EP 2 x SIGMA 105	1.497,00	-
EP 2 x SIGMA 205	1.660,00	-
EP 2 x SIGMA 303	1.867,00	3.368,00
EP 2 x SIGMA 304	1.886,00	3.388,00
EP 2 x SIGMA 305	1.923,00	3.425,00
EP 2 x SIGMA 306	1.967,00	3.530,00
EP 2 x SIGMA 307	1.993,00	3.557,00
EP 2 x SIGMA 403	1.927,00	3.428,00
EP 2 x SIGMA 404	1.978,00	3.542,00

V-NOX

MODELO EQUIPO 2 Bombas / 2 Pumps	P.V.P. CUADRO NORMAL	P.V.P. CUADRO VARIO SYSTEM
EP 2 x V-NOX 303 MONOF	1.960,00	-
EP 2 x V-NOX 304 MONOF	1.984,00	-
EP 2 x V-NOX 305 MONOF	2.017,00	-
EP 2 x V-NOX 403 MONOF	2.070,00	-
EP 2 x V-NOX 303	1.914,00	3.415,00
EP 2 x V-NOX 304	1.927,00	3.429,00
EP 2 x V-NOX 305	1.971,00	3.473,00
EP 2 x V-NOX 306	2.046,00	3.611,00
EP 2 x V-NOX 307	2.074,00	3.639,00
EP 2 x V-NOX 308	2.318,00	3.981,00
EP 2 x V-NOX 309	2.356,00	3.944,00
EP 2 x V-NOX 310	2.447,00	4.214,00
EP 2 x V-NOX 403	2.012,00	3.513,00
EP 2 x V-NOX 404	2.095,00	3.660,00
EP 2 x V-NOX 405	2.356,00	4.019,00
EP 2 x V-NOX 406	2.388,00	4.051,00
EP 2 x V-NOX 407	2.492,00	4.333,00

- En el momento de pasar pedido deben especificar tensión de trabajo.
- En caso de pasar pedido de equipo con variador de frecuencia, la denominación de éste debe incluir el término VARIO ALT, p.ej.: EP 2 x V-NOX 305 (equipo con cuadro normal) VARIO ALT 2 x V-NOX 305 (equipo con cuadro con variador de frecuencia y alternancia).
- Recuerden que equipos con cuadro normal, falta incluir el depósito de membrana o el depósito galvanizado con sus correspondientes inyectores (1 por bomba). Pueden seleccionar el depósito idóneo en el Catálogo General. Los equipos con variador de frecuencia ya incorporan un pequeño depósito para su óptimo funcionamiento, por lo cual no es necesario proveer ningún otro depósito.

EQUIPOS DE PRESIÓN DE 2 BOMBAS

XV-F 5-45

MODELO EQUIPO 2 Bombas / 2 Pumps	P.V.P. CUADRO NORMAL	P.V.P. CUADRO VARIO SYSTEM
EP 2 x XV-F 5-8	2.357,00	4.120,00
EP 2 x XV-F 5-10	2.518,00	4.482,00
EP 2 x XV-F 5-14	2.728,00	4.784,00
EP 2 x XV-F 5-16	2.806,00	4.869,00
EP 2 x XV-F 5-20	3.264,00	5.392,00*
EP 2 x XV-F 5-29	4.242,00	6.660,00*
EP 2 x XV-F 5-36	5.501,00	8.396,00*
EP 2 x XV-F 10-6	2.837,00	4.899,00
EP 2 x XV-F 10-9	3.322,00	5.538,00
EP 2 x XV-F 10-10	3.589,00	6.188,00
EP 2 x XV-F 10-12	3.670,00	6.188,00*
EP 2 x XV-F 10-16	5.082,00	7.943,00*
EP 2 x XV-F 10-22	6.184,00	10.170,00*
EP 2 x XV-F 15-5	3.786,00	6.401,00
EP 2 x XV-F 15-7	4.947,00	7.938,00
EP 2 x XV-F 15-9	5.268,00	8.564,00*
EP 2 x XV-F 15-14	7.666,00	11.646,00*
EP 2 x XV-F 15-17	8.479,00	13.430,00*
EP 2 x XV-F 20-5	5.093,00	7.672,00
EP 2 x XV-F 20-7	5.558,00	8.502,00
EP 2 x XV-F 20-10	7.274,00	10.615,00*
EP 2 x XV-F 20-14	8.820,00	13.064,00*
EP 2 x XV-F 20-17	9.826,00	14.470,00*
EP 2 x XV-F 32-3	6.555,00	9.134,00
EP 2 x XV-F 32-4	7.031,00	9.975,00
EP 2 x XV-F 32-6	8.991,00	12.332,00
EP 2 x XV-F 32-8	10.106,00	14.350,00*
EP 2 x XV-F 32-10	11.299,00	15.943,00*
EP 2 x XV-F 32-12	12.934,00	18.429,00*
EP 2 x XV-F 32-14	15.609,00	21.686,00*
EP 2 x XV-F 45-2	7.069,00	10.013,00
EP 2 x XV-F 45-3	8.836,00	12.263,00
EP 2 x XV-F 45-4	9.527,00	13.858,00
EP 2 x XV-F 45-5	10.527,00	15.171,00*
EP 2 x XV-F 45-6	12.077,00	17.572,00*
EP 2 x XV-F 45-9-2	17.903,00	23.941,00*
EP 2 x XV-F 45-10	19.144,00	26.164,00*
EP 2 x XV-F 45-13-2	21.954,00	30.072,00*

XV-F 64-150

MODELO EQUIPO 2 Bombas / 2 Pumps	P.V.P. CUADRO NORMAL	P.V.P. CUADRO VARIO SYSTEM
EP 2 x XV-F 64-2	8.794,00	12.222,00
EP 2 x XV-F 64-3-1	9.702,00	14.033,00
EP 2 x XV-F 64-4-2	10.744,00	15.475,00
EP 2 x XV-F 64-4	11.895,00	17.390,00*
EP 2 x XV-F 64-6-2	14.872,00	20.910,00*
EP 2 x XV-F 64-7-1	20.323,00	27.343,00*
EP 2 x XV-F 64-8-1	22.348,00	30.428,00*
EP 2 x XV-F 90-2-2	9.198,00	12.626,00
EP 2 x XV-F 90-2	9.769,00	14.100,00
EP 2 x XV-F 90-3-2	10.873,00	15.604,00
EP 2 x XV-F 90-3	12.225,00	17.809,00
EP 2 x XV-F 90-4	14.944,00	20.978,00*
EP 2 x XV-F 90-5	20.603,00	27.618,00*
EP 2 x XV-F 90-6	22.617,00	30.692,00*
EP 2 X XV-F 120-1	15.324,00	18.666,00
EP 2 X XV-F 120-2-1	18.445,00	23.065,00
EP 2 X XV-F 120-2	19.533,00	25.004,00
EP 2 X XV-F 120-3	23.593,00	29.592,00
EP 2 X XV-F 120-4-1	26.092,00	33.058,00*
EP 2 X XV-F 120-5-1	29.194,00	37.145,00*
EP 2 X XV-F 120-6-1	35.876,00	44.855,00*
EP 2 X XV-F 120-7	47.317,00	57.492,00*
EP 2 X XV-F 150-1-1	15.372,00	18.715,00
EP 2 X XV-F 150-1	16.080,00	20.315,00
EP 2 X XV-F 150-2-1	19.405,00	24.875,00
EP 2 X XV-F 150-3-2	23.773,00	29.772,00
EP 2 X XV-F 150-3	24.706,00	31.672,00
EP 2 X XV-F 150-4-1	27.797,00	35.748,00*
EP 2 X XV-F 150-5-2	34.635,00	43.614,00*
EP 2 X XV-F 150-6	46.249,00	56.424,00*

***LOS PRECIOS CON ASTERISCO INDICAN QUE NO SE INCLUYE EL ACUMULADOR**

***THE PRICES WITH ASTERISK INDICATE THAT THE PRESSURE VESSEL IS NOT INCLUDED**

* EL P.V.P. DE LOS EQUIPOS REFLEJADOS CORRESPONDE A TENSIÓN DE TRABAJO TRIF.-400V. PARA OTRAS TENSIONES: MONOFÁSICA O TRIF.-230V ROGAMOS CONSULTEN SUPLEMENTOS.



EQUIPOS DE PRESIÓN DE 3 BOMBAS

SIGMA

MODELO EQUIPO 1 Bomba / 1 Pump	P.V.P. CUADRO NORMAL	P.V.P. CUADRO VARIO SYSTEM
EP 3 x SIGMA 105	2.433,00	-
EP 3 x SIGMA 205	2.677,00	-
EP 3 x SIGMA 303	2.889,00	4.723,00
EP 3 x SIGMA 304	2.918,00	4.753,00
EP 3 x SIGMA 305	2.974,00	4.809,00
EP 3 x SIGMA 306	3.085,00	4.983,00
EP 3 x SIGMA 307	3.125,00	5.023,00
EP 3 x SIGMA 403	3.346,00	5.183,00
EP 3 x SIGMA 404	3.470,00	5.367,00

- En el momento de pasar pedido deben especificar tensión de trabajo.
- En caso de pasar pedido de equipo con variador de frecuencia, la denominación de éste debe incluir el término VARIO ALT, p.ej.: EP 3 x V-NOX 305 (equipo con cuadro normal) VARIO ALT 3 x V-NOX 305 (equipo con cuadro con variador de frecuencia y alternancia).
- Recuerden que equipos con cuadro normal, falta incluir el depósito de membrana o el depósito galvanizado con sus correspondientes inyectores (1 por bomba). Pueden seleccionar el depósito idóneo en el Catálogo General. Los equipos con variador de frecuencia ya incorporan un pequeño depósito para su óptimo funcionamiento, por lo cual no es necesario proveer ningún otro depósito.

V-NOX

MODELO EQUIPO 1 Bomba / 1 Pump	P.V.P. CUADRO NORMAL	P.V.P. CUADRO VARIO SYSTEM
EP 3 x V-NOX 303	2.959,00	4.794,00
EP 3 x V-NOX 304	2.980,00	4.815,00
EP 3 x V-NOX 305	3.046,00	4.880,00
EP 3 x V-NOX 306	3.159,00	5.057,00
EP 3 x V-NOX 307	3.200,00	5.098,00
EP 3 x V-NOX 308	3.567,00	5.566,00
EP 3 x V-NOX 309	3.621,00	5.590,00
EP 3 x V-NOX 310	3.770,00	5.912,00
EP 3 x V-NOX 403	3.473,00	5.308,00
EP 3 x V-NOX 404	3.599,00	5.497,00
EP 3 x V-NOX 405	3.991,00	5.990,00
EP 3 x V-NOX 406	4.039,00	6.038,00
EP 3 x V-NOX 407	4.205,00	6.378,00

EQUIPOS DE PRESIÓN DE 3 BOMBAS

XV-F 5-45

MODELO EQUIPO 1 Bomba / 1 Pump	P.V.P. CUADRO NORMAL	P.V.P. CUADRO VARIO SYSTEM
EP 3 x XV-F 5-8	3.630,00	5.431,00
EP 3 x XV-F 5-10	3.872,00	5.848,00
EP 3 x XV-F 5-14	4.188,00	6.232,00
EP 3 x XV-F 5-16	4.306,00	6.349,00
EP 3 x XV-F 5-20	4.990,00	7.110,00*
EP 3 x XV-F 5-29	6.470,00	8.655,00*
EP 3 x XV-F 5-36	8.058,00	10.521,00*
EP 3 x XV-F 10-6	4.341,00	6.385,00
EP 3 x XV-F 10-9	5.068,00	7.221,00
EP 3 x XV-F 10-10	5.493,00	7.949,00
EP 3 x XV-F 10-12	5.612,00	8.034,00*
EP 3 x XV-F 10-16	7.424,00	10.010,00*
EP 3 x XV-F 10-22	9.075,00	12.737,00*
EP 3 x XV-F 15-5	5.685,00	8.141,00
EP 3 x XV-F 15-7	7.242,00	9.888,00
EP 3 x XV-F 15-9	7.671,00	10.812,00*
EP 3 x XV-F 15-14	11.398,00	14.865,00*
EP 3 x XV-F 15-17	12.742,00	17.432,00*
EP 3 x XV-F 20-5	7.509,00	10.375,00
EP 3 x XV-F 20-7	8.153,00	11.591,00
EP 3 x XV-F 20-10	10.783,00	14.672,00*
EP 3 x XV-F 20-14	13.321,00	18.403,00*
EP 3 x XV-F 20-17	14.651,00	20.234,00*
EP 3 x XV-F 32-3	9.652,00	12.518,00
EP 3 x XV-F 32-4	10.313,00	13.751,00
EP 3 x XV-F 32-6	13.264,00	17.153,00
EP 3 x XV-F 32-8	15.151,00	20.365,00*
EP 3 x XV-F 32-10	16.762,00	22.344,00*
EP 3 x XV-F 32-12	19.321,00	25.719,00*
EP 3 x XV-F 32-14	23.419,00	30.106,00*
EP 3 x XV-F 45-2	10.405,00	13.844,00
EP 3 x XV-F 45-3	13.076,00	17.001,00
EP 3 x XV-F 45-4	14.328,00	19.578,00
EP 3 x XV-F 45-5	15.646,00	21.362,00*
EP 3 x XV-F 45-6	18.096,00	24.627,00*
EP 3 x XV-F 45-9-2	26.872,00	33.522,00*
EP 3 x XV-F 45-10	28.544,00	36.249,00*
EP 3 x XV-F 45-13-2	31.708,00	42.354,00*

XV-F 64-150

MODELO EQUIPO 1 Bomba / 1 Pump	P.V.P. CUADRO NORMAL	P.V.P. CUADRO VARIO SYSTEM
EP 3 x XV-F 64-2	13.102,00	17.027,00
EP 3 x XV-F 64-3-1	14.678,00	19.928,00
EP 3 x XV-F 64-4-2	16.063,00	21.814,00
EP 3 x XV-F 64-4	17.912,00	24.442,00*
EP 3 x XV-F 64-6-2	22.293,00	29.076,00*
EP 3 x XV-F 64-7-1	30.281,00	37.986,00*
EP 3 x XV-F 64-8-1	32.680,00	43.288,00*
EP 3 x XV-F 90-2-2	13.791,00	17.716,00
EP 3 x XV-F 90-2	14.862,00	20.113,00
EP 3 x XV-F 90-3-2	16.295,00	22.047,00
EP 3 x XV-F 90-3	18.496,00	25.062,00
EP 3 x XV-F 90-4	22.498,00	29.281,00*
EP 3 x XV-F 90-5	30.797,00	38.502,00*
EP 3 x XV-F 90-6	33.167,00	43.775,00*
EP 3 x XV-F 120-1	22.576,00	26.388,00
EP 3 x XV-F 120-2-1	27.284,00	32.873,00
EP 3 x XV-F 120-2	29.041,00	35.445,00
EP 3 x XV-F 120-3	35.227,00	41.896,00
EP 3 x XV-F 120-4-1	38.784,00	46.478,00*
EP 3 x XV-F 120-5-1	42.804,00	53.432,00*
EP 3 x XV-F 120-6-1	53.359,00	65.044,00*
EP 3 x XV-F 120-7	71.606,00	83.031,00*
EP 3 x XV-F 150-1-1	22.649,00	26.461,00
EP 3 x XV-F 150-1	23.915,00	29.033,00
EP 3 x XV-F 150-2-1	28.848,00	35.253,00
EP 3 x XV-F 150-3-2	35.497,00	42.165,00
EP 3 x XV-F 150-3	36.707,00	44.402,00
EP 3 x XV-F 150-4-1	40.708,00	51.337,00*
EP 3 x XV-F 150-5-2	51.497,00	63.315,00*
EP 3 x XV-F 150-6	70.005,00	81.429,00*

***LOS PRECIOS CON ASTERISCO INDICAN QUE NO SE INCLUYE EL ACUMULADOR**

***THE PRICES WITH ASTERISK INDICATE THAT THE PRESSURE VESSEL IS NOT INCLUDED**

* EL P.V.P. DE LOS EQUIPOS REFLEJADOS CORRESPONDE A TENSIÓN DE TRABAJO TRIF.-400V. PARA OTRAS TENSIONES: MONOFÁSICA O TRIF.-230V ROGAMOS CONSULTEN SUPLEMENTOS.



EQUIPOS DE PRESIÓN DE 4 BOMBAS

SIGMA

MODELO EQUIPO 1 Bomba / 1 Pump	P.V.P. CUADRO NORMAL	P.V.P. CUADRO VARIO SYSTEM
EP 4 x SIGMA 105	3.110,00	-
EP 4 x SIGMA 205	3.436,00	-
EP 4 x SIGMA 303	3.894,00	6.174,00
EP 4 x SIGMA 304	3.933,00	6.213,00
EP 4 x SIGMA 305	4.008,00	6.287,00
EP 4 x SIGMA 306	4.158,00	6.503,00
EP 4 x SIGMA 307	4.211,00	6.557,00
EP 4 x SIGMA 403	4.021,00	6.301,00
EP 4 x SIGMA 404	4.188,00	6.534,00

- En el momento de pasar pedido deben especificar tensión de trabajo.
- En caso de pasar pedido de equipo con variador de frecuencia, la denominación de éste debe incluir el término VARIO ALT, p.ej.: EP 4 x V-NOX 305 (equipo con cuadro normal) VARIO ALT 4 x V-NOX 305 (equipo con cuadro con variador de frecuencia y alternancia).
- Recuerden que equipos con cuadro normal, falta incluir el depósito de membrana o el depósito galvanizado con sus correspondientes inyectoros (1 por bomba). Pueden seleccionar el depósito idóneo en el Catálogo General. Los equipos con variador de frecuencia ya incorporan un pequeño depósito para su óptimo funcionamiento, por lo cual no es necesario proveer ningún otro depósito.

V-NOX

MODELO EQUIPO 1 Bomba / 1 Pump	P.V.P. CUADRO NORMAL	P.V.P. CUADRO VARIO SYSTEM
EP 4 x V-NOX 303	3.988,00	6.268,00
EP 4 x V-NOX 304	4.016,00	6.295,00
EP 4 x V-NOX 305	4.103,00	6.383,00
EP 4 x V-NOX 306	4.256,00	6.601,00
EP 4 x V-NOX 307	4.311,00	6.656,00
EP 4 x V-NOX 308	4.811,00	7.249,00
EP 4 x V-NOX 309	4.882,00	7.289,00
EP 4 x V-NOX 310	5.068,00	7.653,00
EP 4 x V-NOX 403	4.191,00	6.471,00
EP 4 x V-NOX 404	4.361,00	6.706,00
EP 4 x V-NOX 405	4.893,00	7.332,00
EP 4 x V-NOX 406	4.957,00	7.396,00
EP 4 x V-NOX 407	5.166,00	7.782,00

EQUIPOS DE PRESIÓN DE 4 BOMBAS

XV-F 5-45

MODELO EQUIPO 1 Bomba / 1 Pump	P.V.P. CUADRO NORMAL	P.V.P. CUADRO VARIO SYSTEM
EP 4 x XV-F 5-8	4.613,00	6.894,00
EP 4 x XV-F 5-10	4.935,00	7.390,00
EP 4 x XV-F 5-14	5.358,00	7.883,00
EP 4 x XV-F 5-16	5.514,00	8.040,00
EP 4 x XV-F 5-20	6.438,00	9.030,00*
EP 4 x XV-F 5-29	8.396,00	11.058,00*
EP 4 x XV-F 5-36	11.055,00	14.141,00*
EP 4 x XV-F 10-6	5.781,00	8.307,00
EP 4 x XV-F 10-9	6.762,00	9.388,00
EP 4 x XV-F 10-10	7.321,00	10.265,00
EP 4 x XV-F 10-12	7.478,00	10.389,00*
EP 4 x XV-F 10-16	10.417,00	12.620,00*
EP 4 x XV-F 10-22	12.683,00	16.782,00*
EP 4 x XV-F 15-5	7.861,00	10.806,00
EP 4 x XV-F 15-7	10.074,00	13.329,00
EP 4 x XV-F 15-9	10.623,00	14.151,00*
EP 4 x XV-F 15-14	15.454,00	19.342,00*
EP 4 x XV-F 15-17	17.100,00	21.640,00*
EP 4 x XV-F 20-5	10.381,00	13.907,00
EP 4 x XV-F 20-7	11.215,00	15.073,00
EP 4 x XV-F 20-10	14.343,00	18.687,00*
EP 4 x XV-F 20-14	17.797,00	22.716,00*
EP 4 x XV-F 20-17	19.768,00	25.112,00*
EP 4 x XV-F 32-3	12.819,00	16.346,00
EP 4 x XV-F 32-4	13.676,00	17.534,00
EP 4 x XV-F 32-6	17.628,00	21.972,00
EP 4 x XV-F 32-8	20.215,00	25.266,00*
EP 4 x XV-F 32-10	22.576,00	27.921,00*
EP 4 x XV-F 32-12	25.936,00	34.222,00*
EP 4 x XV-F 32-14	31.190,00	39.747,00*
EP 4 x XV-F 45-2	13.904,00	17.762,00
EP 4 x XV-F 45-3	17.486,00	21.866,00
EP 4 x XV-F 45-4	19.226,00	24.314,00
EP 4 x XV-F 45-5	21.213,00	26.690,00*
EP 4 x XV-F 45-6	24.402,00	32.821,00*
EP 4 x XV-F 45-9-2	35.894,00	44.412,00*
EP 4 x XV-F 45-10	38.192,00	47.943,00*
EP 4 x XV-F 45-13-2	42.887,00	54.569,00*

XV-F 64-150

MODELO EQUIPO 1 Bomba / 1 Pump	P.V.P. CUADRO NORMAL	P.V.P. CUADRO VARIO SYSTEM
EP 4 x XV-F 64-2	17.748,00	22.129,00
EP 4 x XV-F 64-3-1	19.920,00	25.007,00
EP 4 x XV-F 64-4-2	21.997,00	27.510,00
EP 4 x XV-F 64-4	24.383,00	32.802,00*
EP 4 x XV-F 64-6-2	30.042,00	38.693,00*
EP 4 x XV-F 64-7-1	40.761,00	50.511,00*
EP 4 x XV-F 64-8-1	44.036,00	55.681,00*
EP 4 x XV-F 90-2-2	18.358,00	22.746,00
EP 4 x XV-F 90-2	19.864,00	24.952,00
EP 4 x XV-F 90-3-2	22.064,00	27.578,00
EP 4 x XV-F 90-3	24.862,00	33.317,00
EP 4 x XV-F 90-4	29.996,00	38.648,00*
EP 4 x XV-F 90-5	41.130,00	50.880,00*
EP 4 x XV-F 90-6	44.384,00	56.028,00*
EP 4 x XV-F 120-1	30.116,00	34.357,00
EP 4 x XV-F 120-2-1	36.663,00	41.979,00
EP 4 x XV-F 120-2	38.928,00	47.186,00
EP 4 x XV-F 120-3	46.946,00	55.463,00
EP 4 x XV-F 120-4-1	51.756,00	61.460,00*
EP 4 x XV-F 120-5-1	57.209,00	68.839,00*
EP 4 x XV-F 120-6-1	72.585,00	84.513,00*
EP 4 x XV-F 120-7	94.369,00	107.014,00*
EP 4 x XV-F 150-1-1	30.214,00	34.455,00
EP 4 x XV-F 150-1	31.978,00	36.908,00
EP 4 x XV-F 150-2-1	38.671,00	46.929,00
EP 4 x XV-F 150-3-2	47.305,00	55.823,00
EP 4 x XV-F 150-3	48.988,00	58.693,00
EP 4 x XV-F 150-4-1	54.415,00	66.045,00*
EP 4 x XV-F 150-5-2	70.103,00	82.164,00*
EP 4 x XV-F 150-6	92.234,00	104.879,00*

***LOS PRECIOS CON ASTERISCO INDICAN QUE NO SE INCLUYE EL ACUMULADOR**

***THE PRICES WITH ASTERISK INDICATE THAT THE PRESSURE VESSEL IS NOT INCLUDED**

* EL P.V.P. DE LOS EQUIPOS REFLEJADOS CORRESPONDE A TENSIÓN DE TRABAJO TRIF.-400V. PARA OTRAS TENSIONES: MONOFÁSICA O TRIF.-230V ROGAMOS CONSULTEN SUPLEMENTOS.

COLECTORES DE PRUEBAS CON CAUDALÍMETRO

Modelo ECO F-300



MODELO COLECTOR	P.V.P.
COLECTOR PRUEBAS ECO F-300 - DN 50	314,00
COLECTOR PRUEBAS ECO F-300 - DN 65	344,00
COLECTOR PRUEBAS ECO F-300 - DN 80	476,00
COLECTOR PRUEBAS ECO F-300 - DN 100	550,00
COLECTOR PRUEBAS ECO F-300 - DN 150	945,00
COLECTOR PRUEBAS ECO F-300 - DN 200	1.318,00

CAUDALÍMETROS SUELTOS

CAUDALÍMETROS SUELTOS ECO F-300



MODELO	P.V.P.
CAUDALIMETRO 1-1/2' -50 MM (3-21 M3/H) F30050M	192,00
CAUDALIMETRO 2' - 63 MM (6-28 M3/H) F30063M	203,00
CAUDALIMETRO 2-1/2' -75 MM (9-42 M3/H) F30075M	232,00
CAUDALIMETRO 3' -90 MM (12-51 M3/H) F30090M	261,00
CAUDALIMETRO 4' -110 MM (36-108 M3/H) F30110M	300,00
CAUDALIMETRO 6' -160 MM (54-192 M3/H) F30160M	485,00
CAUDALIMETRO 8' -200 MM (90-306 M3/H) F30200M	539,00

	1 1/2"	2"	2 1/2"	3"	4"	6"	8"
CAUDAL mínimo	3	6	9	12	36	54	90
CAUDAL máximo	21	28	42	51	108	192	306

EQUIPOS CONTRAINCENDIOS UNE 23500:2018

U.E. - 1 Bomba Principal Eléctrica + Jockey - Equipamiento sencillo

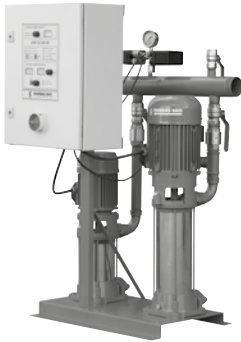

MODELO MODEL	P.V.P	MODELO MODEL	P.V.P
X.E / 406 (UNE 2012 - ANEXO C)	2.408,00	U.E / 420 A	3.943,00
X.E / 407 (UNE 2012 - ANEXO C)	2.658,00	U.E / 425 B	4.446,00
X.E / 15-7 (UNE 2012 - ANEXO C)	3.901,00	U.E / 425 A	5.533,00
U.E / 404	2.464,00	U.E / 520 C	4.399,00
U.E / 405	2.585,00	U.E / 520 B	4.506,00
U.E / 406	2.672,00	U.E / 520 A	5.560,00
U.E / 407	2.907,00	U.E / 525 C	5.682,00
U.E / 15-7	4.048,00	U.E / 525 B	6.279,00
U.E / 15-9	4.281,00	U.E / 525 A	6.654,00
U.E / 420 B	3.877,00		

U.E.E. - 2 Bombas Principales Eléctricas + Jockey - Equipamiento sencillo

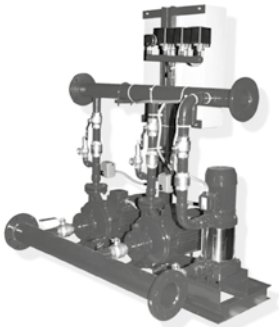

MODELO MODEL	P.V.P	MODELO MODEL	P.V.P
U.E.E / 404	4.517,00	U.E.E / 425 B	7.948,00
U.E.E / 405	4.761,00	U.E.E / 425 A	10.014,00
U.E.E / 406	4.862,00	U.E.E / 520 C	7.950,00
U.E.E / 407	5.106,00	U.E.E / 520 B	8.158,00
U.E.E / 15-7	6.966,00	U.E.E / 520 A	10.120,00
U.E.E / 15-9	7.378,00	U.E.E / 525 C	10.315,00
U.E.E / 420 B	7.011,00	U.E.E / 525 B	11.498,00
U.E.E / 420 A	7.150,00	U.E.E / 525 A	12.143,00

U.D. - 1 Bomba Principal Diésel + Jockey - Equipamiento sencillo

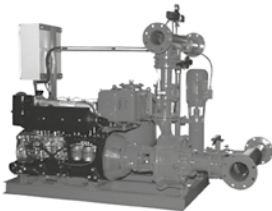

MODELO MODEL	P.V.P	MODELO MODEL	P.V.P
U.D / 404	6.399,00	U.D / 420 A	11.161,00
U.D / 405	6.399,00	U.D / 425 B	11.209,00
U.D / 406	6.474,00	U.D / 520 C	11.247,00
U.D / 407	6.631,00	U.D / 520 B	11.247,00
U.D / 15-7*	10.534,00	U.D / 520 A	11.247,00
U.D / 420 B	11.161,00		

*Altura máxima de 80 mca / Maximum pressure 80 wcm

U.E.D - PPAL Eléctrica + PPAL Diésel + Jockey - Equipamiento sencillo

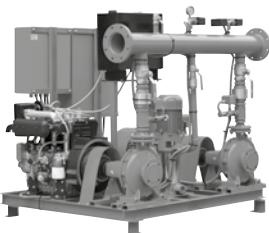

MODELO MODEL	P.V.P	MODELO MODEL	P.V.P
U.E.D / 404	7.846,00	U.E.D / 420 A	13.835,00
U.E.D / 405	7.968,00	U.E.D / 425 B	14.784,00
U.E.D / 406	8.056,00	U.E.D / 520 C	14.802,00
U.E.D / 407	8.256,00	U.E.D / 520 B	14.910,00
U.E.D / 15-7*	13.041,00	U.E.D / 520 A	15.888,00
U.E.D / 420 B	13.767,00		

*Altura máxima de 80 mca / Maximum pressure 80 wcm

**PARA OTRAS NORMATIVAS CONSULTE
CON NUESTRO DEPARTAMENTO COMERCIAL**

EQUIPOS CONTRA INCENDIOS UNE 23500:2018

U.E. - 1 Bomba Principal Eléctrica + Jockey - Equipamiento Superior



MODELO MODEL	P.V.P.	MODELO MODEL	P.V.P.
U.E / 316 S 17 /7.5	6.462,00	U.E / 625 S 24 /50	10.712,00
U.E / 320 S 20 /10	6.596,00	U.E / 625 S 25 /50	10.712,00
U.E / 320 S 22 /15	7.132,00	U.E / 625 S 26 /60	11.360,00
U.E / 325 S 23 /25	8.096,00	U.E / 631 S 27 /75	12.781,00
U.E / 325 S 25 /30	8.796,00	U.E / 631 S 28 /100	14.927,00
U.E / 325 S 26 /30	8.812,00	U.E / 820 S 20 /50	10.633,00
U.E / 425 S 24 /25	8.096,00	U.E / 820 S 21 /60	11.098,00
U.E / 420 S 22 /20	7.448,00	U.E / 825 S 23 /75	12.572,00
U.E / 425 S 23 /25	8.110,00	U.E / 825 S 24 /100	14.539,00
U.E / 425 S 25 /30	8.846,00	U.E / 825 S 25 /100	14.863,00
U.E / 425 S 26 /30	9.028,00	U.E / 825 S 27 /125	15.539,00
U.E / 525 S 22 /30	9.028,00	U.E / 831 S 28 /125	15.949,00
U.E / 525 S 23 /30	9.028,00	U.E / 831 S 29 /150	19.409,00
U.E / 525 S 24 /40	9.740,00	U.E / 1020 S 21 /75	12.644,00
U.E / 525 S 25 /40	9.740,00	U.E / 1020 S 22 /100	14.747,00
U.E / 525 S 26 /50	10.172,00	U.E / 1025 S 24 /100	15.149,00
U.E / 652 S 20 /30	9.165,00	U.E / 1025 S 25 /125	15.930,00
U.E / 652 S 21 /40	9.854,00	U.E / 1025 S 26 /150	19.430,00
U.E / 652 S 22 /40	9.877,00		

U.E.E. - 2 Principales Eléctricas + Jockey - Equipamiento superior

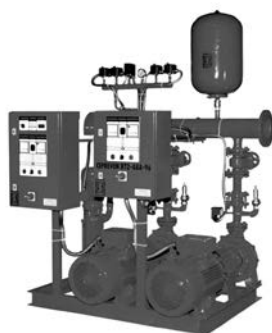

MODELO MODEL	P.V.P.	MODELO MODEL	P.V.P.
U.E.E / 316 S 17 /7.5	11.678,00	U.E.E / 625 S 24 /50	20.032,00
U.E.E / 320 S 20 /10	12.022,00	U.E.E / 625 S 25 /50	20.032,00
U.E.E / 320 S 22 /15	13.054,00	U.E.E / 625 S 26 /60	21.107,00
U.E.E / 325 S 23 /25	14.943,00	U.E.E / 631 S 27 /75	23.947,00
U.E.E / 325 S 25 /30	16.174,00	U.E.E / 631 S 28 /100	28.062,00
U.E.E / 325 S 26 /30	16.190,00	U.E.E / 820 S 20 /50	19.798,00
U.E.E / 425 S 24 /25	14.957,00	U.E.E / 820 S 21 /60	20.690,00
U.E.E / 420 S 22 /20	13.666,00	U.E.E / 825 S 23 /75	23.653,00
U.E.E / 425 S 23 /25	14.977,00	U.E.E / 825 S 24 /100	27.567,00
U.E.E / 425 S 25 /30	16.415,00	U.E.E / 825 S 25 /100	27.912,00
U.E.E / 425 S 26 /30	16.598,00	U.E.E / 825 S 27 /125	29.237,00
U.E.E / 525 S 22 /30	16.713,00	U.E.E / 831 S 28 /125	30.057,00
U.E.E / 525 S 23 /30	16.713,00	U.E.E / 831 S 29 /150	36.936,00
U.E.E / 525 S 24 /40	18.121,00	U.E.E / 1020 S 21 /75	23.767,00
U.E.E / 525 S 25 /40	18.121,00	U.E.E / 1020 S 22 /100	27.837,00
U.E.E / 525 S 26 /50	18.773,00	U.E.E / 1025 S 24 /100	28.642,00
U.E.E / 652 S 20 /30	16.983,00	U.E.E / 1025 S 25 /125	30.071,00
U.E.E / 652 S 21 /40	18.363,00	U.E.E / 1025 S 26 /150	36.993,00
U.E.E / 652 S 22 /40	18.391,00		

**PARA OTRAS NORMATIVAS CONSULTE
CON NUESTRO DEPARTAMENTO COMERCIAL**

EQUIPOS CONTRAINCENDIOS UNE 23500:2018

U.D. - 1 Bomba Principal Diésel + Jockey - Equipamiento superior

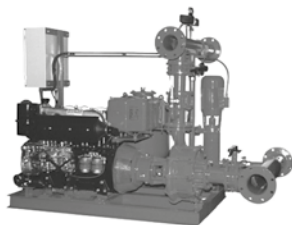

MODELO MODEL	P.V.P.	MODELO MODEL	P.V.P.
U.D / 316 S 17 /7.5	10.493,00	U.D / 625 S 24 /50	18.030,00
U.D / 320 S 20 /10	10.606,00	U.D / 625 S 25 /50	18.030,00
U.D / 320 S 22 /15	13.242,00	U.D / 625 S 26 /60	19.473,00
U.D / 325 S 23 /25	15.673,00	U.D / 631 S 27 /75	20.509,00
U.D / 325 S 25 /30	16.670,00	U.D / 631 S 28 /100	23.065,00
U.D / 325 S 26 /30	16.686,00	U.D / 820 S 20 /50	17.949,00
U.D / 425 S 24 /25	15.683,00	U.D / 820 S 21 /60	19.210,00
U.D / 420 S 22 /20	13.981,00	U.D / 825 S 23 /75	20.296,00
U.D / 425 S 23 /25	15.697,00	U.D / 825 S 24 /100	22.685,00
U.D / 425 S 25 /30	16.534,00	U.D / 825 S 25 /100	23.017,00
U.D / 425 S 26 /30	16.716,00	U.D / 825 S 27 /125	24.179,00
U.D / 525 S 22 /30	16.716,00	U.D / 831 S 28 /125	24.588,00
U.D / 525 S 23 /30	16.733,00	U.D / 831 S 29 /150	31.411,00
U.D / 525 S 24 /40	16.916,00	U.D / 1020 S 21 /75	20.370,00
U.D / 525 S 25 /40	16.916,00	U.D / 1020 S 22 /100	22.892,00
U.D / 525 S 26 /50	17.513,00	U.D / 1025 S 24 /100	23.309,00
U.D / 652 S 20 /30	16.990,00	U.D / 1025 S 25 /125	24.569,00
U.D / 652 S 21 /40	16.991,00	U.D / 1025 S 26 /150	31.395,00
U.D / 652 S 22 /40	17.013,00		

U.E.D - PPAL Eléctrica + PPAL Diésel + Jockey - Equipamiento superior

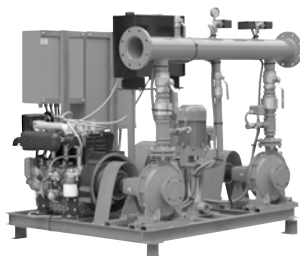

MODELO MODEL	P.V.P.	MODELO MODEL	P.V.P.
U.E.D / 316 S 17 /7.5	15.170,00	U.E.D / 625 S 24 /50	26.802,00
U.E.D / 320 S 20 /10	15.454,00	U.E.D / 625 S 25 /50	26.802,00
U.E.D / 320 S 22 /15	18.592,00	U.E.D / 625 S 26 /60	28.710,00
U.E.D / 325 S 23 /25	21.966,00	U.E.D / 631 S 27 /75	31.148,00
U.E.D / 325 S 25 /30	23.480,00	U.E.D / 631 S 28 /100	35.583,00
U.E.D / 325 S 26 /30	23.496,00	U.E.D / 820 S 20 /50	26.566,00
U.E.D / 425 S 24 /25	21.985,00	U.E.D / 820 S 21 /60	28.292,00
U.E.D / 420 S 22 /20	19.628,00	U.E.D / 825 S 23 /75	30.852,00
U.E.D / 425 S 23 /25	22.005,00	U.E.D / 825 S 24 /100	35.087,00
U.E.D / 425 S 25 /30	23.694,00	U.E.D / 825 S 25 /100	35.432,00
U.E.D / 425 S 26 /30	23.876,00	U.E.D / 825 S 27 /125	37.256,00
U.E.D / 525 S 22 /30	23.991,00	U.E.D / 831 S 28 /125	38.076,00
U.E.D / 525 S 23 /30	23.991,00	U.E.D / 831 S 29 /150	48.337,00
U.E.D / 525 S 24 /40	24.718,00	U.E.D / 1020 S 21 /75	30.967,00
U.E.D / 525 S 25 /40	24.718,00	U.E.D / 1020 S 22 /100	35.357,00
U.E.D / 525 S 26 /50	25.582,00	U.E.D / 1025 S 24 /100	36.162,00
U.E.D / 652 S 20 /30	24.222,00	U.E.D / 1025 S 25 /125	38.090,00
U.E.D / 652 S 21 /40	24.921,00	U.E.D / 1025 S 26 /150	48.393,00
U.E.D / 652 S 22 /40	24.949,00		

**PARA OTRAS NORMATIVAS CONSULTE
CON NUESTRO DEPARTAMENTO COMERCIAL**

EQUIPOS CONTRA INCENDIOS EN-12845

N.E. - 1 Bomba Principal Eléctrica + Jockey



MODELO MODEL	P.V.P.	MODELO MODEL	P.V.P.
N.E / 316 S 17 / 7.5	6.290,00	N.E / 625 S 24 / 50	10.488,00
N.E / 320 S 20 / 10	6.424,00	N.E / 625 S 25 / 50	10.488,00
N.E / 320 S 22 / 15	6.961,00	N.E / 625 S 26 / 60	11.136,00
N.E / 325 S 23 / 25	7.904,00	N.E / 631 S 27 / 75	12.557,00
N.E / 325 S 25 / 30	8.604,00	N.E / 631 S 28 / 100	14.703,00
N.E / 325 S 26 / 30	8.620,00	N.E / 820 S 20 / 50	10.381,00
N.E / 425 S 24 / 25	7.904,00	N.E / 820 S 21 / 60	10.847,00
N.E / 420 S 22 / 20	7.260,00	N.E / 825 S 23 / 75	12.321,00
N.E / 425 S 23 / 25	7.922,00	N.E / 825 S 24 / 100	14.287,00
N.E / 425 S 25 / 30	8.654,00	N.E / 825 S 25 / 100	14.612,00
N.E / 425 S 26 / 30	8.836,00	N.E / 825 S 27 / 125	15.288,00
N.E / 525 S 22 / 30	8.820,00	N.E / 831 S 28 / 125	15.697,00
N.E / 525 S 23 / 30	8.820,00	N.E / 831 S 29 / 150	19.158,00
N.E / 525 S 24 / 40	9.529,00	N.E / 1020 S 21 / 75	12.324,00
N.E / 525 S 25 / 40	9.529,00	N.E / 1020 S 22 / 100	14.426,00
N.E / 525 S 26 / 50	9.961,00	N.E / 1025 S 24 / 100	14.829,00
N.E / 652 S 20 / 30	8.944,00	N.E / 1025 S 25 / 125	15.609,00
N.E / 652 S 21 / 40	9.633,00	N.E / 1025 S 26 / 150	19.110,00
N.E / 652 S 22 / 40	9.652,00		

N.E.E. - 2 Principales Eléctricas + Jockey

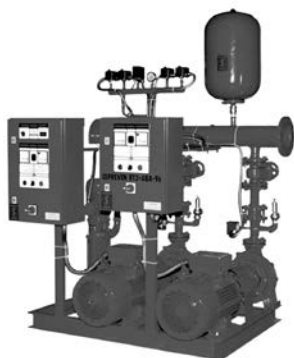

MODELO MODEL	P.V.P.	MODELO MODEL	P.V.P.
N.E.E / 316 S 17 / 7.5	11.354,00	N.E.E / 625 S 24 / 50	19.603,00
N.E.E / 320 S 20 / 10	11.698,00	N.E.E / 625 S 25 / 50	19.603,00
N.E.E / 320 S 22 / 15	12.730,00	N.E.E / 625 S 26 / 60	20.678,00
N.E.E / 325 S 23 / 25	14.592,00	N.E.E / 631 S 27 / 75	23.518,00
N.E.E / 325 S 25 / 30	15.824,00	N.E.E / 631 S 28 / 100	27.633,00
N.E.E / 325 S 26 / 30	15.840,00	N.E.E / 820 S 20 / 50	19.315,00
N.E.E / 425 S 24 / 25	14.593,00	N.E.E / 820 S 21 / 60	20.207,00
N.E.E / 420 S 22 / 20	13.309,00	N.E.E / 825 S 23 / 75	23.170,00
N.E.E / 425 S 23 / 25	14.619,00	N.E.E / 825 S 24 / 100	27.084,00
N.E.E / 425 S 25 / 30	16.052,00	N.E.E / 825 S 25 / 100	27.430,00
N.E.E / 425 S 26 / 30	16.234,00	N.E.E / 825 S 27 / 125	28.755,00
N.E.E / 525 S 22 / 30	16.317,00	N.E.E / 831 S 28 / 125	29.574,00
N.E.E / 525 S 23 / 30	16.317,00	N.E.E / 831 S 29 / 150	36.454,00
N.E.E / 525 S 24 / 40	17.719,00	N.E.E / 1020 S 21 / 75	23.146,00
N.E.E / 525 S 25 / 40	17.719,00	N.E.E / 1020 S 22 / 100	27.216,00
N.E.E / 525 S 26 / 50	18.371,00	N.E.E / 1025 S 24 / 100	28.021,00
N.E.E / 652 S 20 / 30	16.561,00	N.E.E / 1025 S 25 / 125	29.450,00
N.E.E / 652 S 21 / 40	17.940,00	N.E.E / 1025 S 26 / 150	36.372,00
N.E.E / 652 S 22 / 40	17.962,00		

**PARA OTRAS NORMATIVAS CONSULTE
CON NUESTRO DEPARTAMENTO COMERCIAL**

EQUIPOS CONTRAINCENDIOS EN-12845

N.D. - 1 Bomba Principal Diésel + Jockey

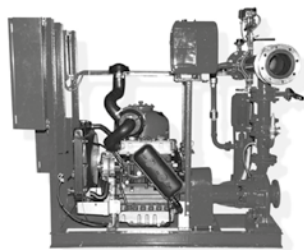

MODELO MODEL	P.V.P.	MODELO MODEL	P.V.P.
N.D / 316 S 17 / 7.5	10.214,00	N.D / 625 S 24 / 50	17.686,00
N.D / 320 S 20 / 10	10.327,00	N.D / 625 S 25 / 50	17.686,00
N.D / 320 S 22 / 15	12.964,00	N.D / 625 S 26 / 60	19.129,00
N.D / 325 S 23 / 25	15.361,00	N.D / 631 S 27 / 75	20.164,00
N.D / 325 S 25 / 30	16.358,00	N.D / 631 S 28 / 100	22.721,00
N.D / 325 S 26 / 30	16.374,00	N.D / 820 S 20 / 50	17.578,00
N.D / 425 S 24 / 25	15.371,00	N.D / 820 S 21 / 60	18.839,00
N.D / 420 S 22 / 20	13.672,00	N.D / 825 S 23 / 75	19.925,00
N.D / 425 S 23 / 25	15.388,00	N.D / 825 S 24 / 100	22.314,00
N.D / 425 S 25 / 30	16.222,00	N.D / 825 S 25 / 100	22.645,00
N.D / 425 S 26 / 30	16.404,00	N.D / 825 S 27 / 125	23.807,00
N.D / 525 S 22 / 30	16.388,00	N.D / 831 S 28 / 125	24.217,00
N.D / 525 S 23 / 30	16.405,00	N.D / 831 S 29 / 150	31.039,00
N.D / 525 S 24 / 40	16.585,00	N.D / 1020 S 21 / 75	19.930,00
N.D / 525 S 25 / 40	16.585,00	N.D / 1020 S 22 / 100	22.452,00
N.D / 525 S 26 / 50	17.181,00	N.D / 1025 S 24 / 100	22.869,00
N.D / 652 S 20 / 30	16.649,00	N.D / 1025 S 25 / 125	24.129,00
N.D / 652 S 21 / 40	16.650,00	N.D / 1025 S 26 / 150	30.955,00
N.D / 652 S 22 / 40	16.669,00		

N.E.D - PPAL Eléctrica + PPAL Diésel + Jockey

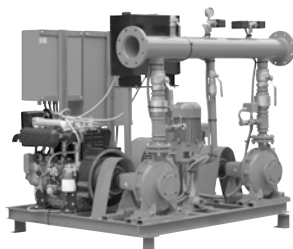

MODELO MODEL	P.V.P.	MODELO MODEL	P.V.P.
N.E.D / 316 S 17 / 7.5	14.750,00	N.E.D / 625 S 24 / 50	26.258,00
N.E.D / 320 S 20 / 10	15.033,00	N.E.D / 625 S 25 / 50	26.258,00
N.E.D / 320 S 22 / 15	18.172,00	N.E.D / 625 S 26 / 60	28.166,00
N.E.D / 325 S 23 / 25	21.307,00	N.E.D / 631 S 27 / 75	30.604,00
N.E.D / 325 S 25 / 30	22.486,00	N.E.D / 631 S 28 / 100	35.039,00
N.E.D / 325 S 26 / 30	22.664,00	N.E.D / 820 S 20 / 50	25.969,00
N.E.D / 425 S 24 / 25	21.344,00	N.E.D / 820 S 21 / 60	27.695,00
N.E.D / 420 S 22 / 20	19.155,00	N.E.D / 825 S 23 / 75	30.255,00
N.E.D / 425 S 23 / 25	21.533,00	N.E.D / 825 S 24 / 100	33.300,00
N.E.D / 425 S 25 / 30	23.215,00	N.E.D / 825 S 25 / 100	34.835,00
N.E.D / 425 S 26 / 30	23.398,00	N.E.D / 825 S 27 / 125	36.659,00
N.E.D / 525 S 22 / 30	23.481,00	N.E.D / 831 S 28 / 125	37.478,00
N.E.D / 525 S 23 / 30	23.481,00	N.E.D / 831 S 29 / 150	47.739,00
N.E.D / 525 S 24 / 40	24.201,00	N.E.D / 1020 S 21 / 75	30.231,00
N.E.D / 525 S 25 / 40	24.201,00	N.E.D / 1020 S 22 / 100	34.621,00
N.E.D / 525 S 26 / 50	24.976,00	N.E.D / 1025 S 24 / 100	35.426,00
N.E.D / 652 S 20 / 30	23.685,00	N.E.D / 1025 S 25 / 125	37.354,00
N.E.D / 652 S 21 / 40	24.383,00	N.E.D / 1025 S 26 / 150	47.658,00
N.E.D / 652 S 22 / 40	24.405,00		

**PARA OTRAS NORMATIVAS CONSULTE
CON NUESTRO DEPARTAMENTO COMERCIAL**



CUADRO ELECTRONICO PARA 1 Y 2 BOMBAS

EASYTRONIC

369,00

EASYTRONIC es cuadro electrónico que puede usarse tanto para controlar un grupo de presión, un conjunto de bombas de aguas sucias o una instalación con bomba de pozo. Puede funcionar en una instalación monofásica o trifásica y en función de la alimentación suministrada podrá controlar y proteger 1 o 2 bombas monofásica o trifásicas.

EASYTRONIC is an electronic panel that can be used to control a pressure booster set, a set of sewage pumps or an installation with a well pump. It can work in a single-phase or three-phase installation and depending on the power supplied it can control and protect 1 or 2 single-phase or three-phase pumps.



Más info:

CUADROS ELÉCTRICOS PARA EQUIPOS DE PRESIÓN

Cuadros Monofásicos

C.V.	CUADROS 1 BOMBA		CUADROS 2 BOMBA	
	Referencia	P.V.P.	Referencia	P.V.P.
0,5 CV	C1PD-0,5-M	266,00	C2PD-0,5-M	441,00
0,75-1 CV	C1PD-1-M	266,00	C2PD-1-M	441,00
1,5 CV	C1PD-1,5-M	272,00	C2PD-1,5-M	454,00
2 CV	C1PD-2-M	290,00	C2PD-2-M	471,00
3 CV	C1PD-3-M	300,00	C2PD-3-M	512,00



Cuadros Trifásicos a 400 V

C.V.	CUADROS 1 BOMBA		CUADROS 2 BOMBA		CUADROS 3 BOMBA		CUADROS 4 BOMBA	
	Referencia	P.V.P.	Referencia	P.V.P.	Referencia	P.V.P.	Referencia	P.V.P.
0,5 CV	C1PD-0,5-T3	268,00	C2PD-0,5-T3	446,00	C3PD-0,5-T3	791,00	C4PD-0,5-T3	962,00
0,75-1 CV	C1PD-1-T3	268,00	C2PD-1-T3	446,00	C3PD-1-T3	791,00	C4PD-1-T3	962,00
1,5 CV	C1PD-1,5-T3	268,00	C2PD-1,5-T3	446,00	C3PD-1,5-T3	791,00	C4PD-1,5-T3	962,00
2 CV	C1PD-2-T3	268,00	C2PD-2-T3	446,00	C3PD-2-T3	794,00	C4PD-2-T3	962,00
3 CV	C1PD-3-T3	268,00	C2PD-3-T3	446,00	C3PD-3-T3	795,00	C4PD-3-T3	965,00
4 CV	C1PD-4-T3	268,00	C2PD-4-T3	447,00	C3PD-4-T3	796,00	C4PD-4-T3	977,00
5,5 CV	C1PD-5,5-T3	274,00	C2PD-5,5-T3	459,00	C3PD-5,5-T3	824,00	C4PD-5,5-T3	1.004,00
7,5 CV	C1PET-7,5-T3	557,00	C2PET-7,5-T3	871,00	C3PET-7,5-T3	1.266,00	C4PET-7,5-T3	1.695,00
10 CV	C1PET-10-T3	565,00	C2PET-10-T3	916,00	C3PET-10-T3	1.291,00	C4PET-10-T3	1.707,00
12,5 CV	C1PET-12,5-T3	591,00	C2PET-12,5-T3	965,00	C3PET-12,5-T3	1.363,00	C4PET-12,5-T3	1.862,00
15 CV	C1PET-15-T3	661,00	C2PET-15-T3	1.080,00	C3PET-15-T3	1.548,00	C4PET-15-T3	2.065,00
20 CV	C1PET-20-T3	810,00	C2PET-20-T3	1.337,00	C3PET-20-T3	2.102,00	C4PET-20-T3	2.863,00
25 CV	C1PET-25-T3	833,00	C2PET-25-T3	1.501,00	C3PET-25-T3	2.202,00	C4PET-25-T3	3.141,00
30 CV	C1PET-30-T3	914,00	C2PET-30-T3	1.607,00	C3PET-30-T3	2.415,00	C4PET-30-T3	3.460,00
40 CV	C1PET-40-T3	1.060,00	C2PET-40-T3	1.952,00	C3PET-40-T3	3.048,00	C4PET-40-T3	4.087,00
50 CV	C1PET-50-T3	1.246,00	C2PET-50-T3	2.426,00	C3PET-50-T3	3.672,00	C4PET-50-T3	4.952,00
60 CV	C1PET-60-T3	1.359,00	C2PET-60-T3	2.901,00	C3PET-60-T3	3.770,00	C4PET-60-T3	5.151,00

TIPO
TYPE

PVP €



CUADRO ELECTRONICO PARA 1 Y 2 BOMBAS

EASYTRONIC
369,00

EASYTRONIC es cuadro electrónico que puede usarse tanto para controlar un grupo de presión, un conjunto de bombas de aguas sucias o una instalación con bomba de pozo. Puede funcionar en una instalación monofásica o trifásica y en función de la alimentación suministrada podrá controlar y proteger 1 o 2 bombas monofásica o trifásicas.

EASYTRONIC is an electronic panel that can be used to control a pressure booster set, a set of sewage pumps or an installation with a well pump. It can work in a single-phase or three-phase installation and depending on the power supplied it can control and protect 1 or 2 single-phase or three-phase pumps.



Más info:

CUADROS ELECTRICOS PARA BOMBAS DE AGUAS SUCIAS

Cuadros Monofásicos

C.V.	CUADROS 1 BOMBA		CUADROS 2 BOMBA	
	Referencia	P.V.P.	Referencia	P.V.P.
0,5 CV	C1FD-0,5-M	295,00	C2FD-0,5-M	474,00
0,75-1 CV	C1FD-1-M	295,00	C2FD-1-M	474,00
1,5 CV	C1FD-1,5-M	302,00	C2FD-1,5-M	487,00
2 CV	C1FD-2-M	318,00	C2FD-2-M	505,00
3 CV	C1FD-3-M	330,00	C2FD-3-M	543,00



Cuadros Trifásicos a 400 V

C.V.	CUADROS 1 BOMBA		CUADROS 2 BOMBA		CUADROS 3 BOMBA		CUADROS 4 BOMBA	
	Referencia	P.V.P.	Referencia	P.V.P.	Referencia	P.V.P.	Referencia	P.V.P.
0,5 CV	C1FD-0,5-T3	297,00	C2FD-0,5-T3	476,00	C3FD-0,5-T3	820,00	C4FD-0,5-T3	992,00
0,75-1 CV	C1FD-1-T3	297,00	C2FD-1-T3	476,00	C3FD-1-T3	820,00	C4FD-1-T3	992,00
1,5 CV	C1FD-1,5-T3	297,00	C2FD-1,5-T3	476,00	C3FD-1,5-T3	820,00	C4FD-1,5-T3	992,00
2 CV	C1FD-2-T3	297,00	C2FD-2-T3	476,00	C3FD-2-T3	823,00	C4FD-2-T3	992,00
3 CV	C1FD-3-T3	297,00	C2FD-3-T3	476,00	C3FD-3-T3	824,00	C4FD-3-T3	994,00
4 CV	C1FD-4-T3	298,00	C2FD-4-T3	477,00	C3FD-4-T3	825,00	C4FD-4-T3	1.008,00
5,5 CV	C1FD-5,5-T3	303,00	C2FD-5,5-T3	489,00	C3FD-5,5-T3	854,00	C4FD-5,5-T3	1.034,00
7,5 CV	C1FET-7,5-T3	588,00	C2FET-7,5-T3	901,00	C3FET-7,5-T3	1.296,00	C4FET-7,5-T3	1.724,00
10 CV	C1FET-10-T3	596,00	C2FET-10-T3	947,00	C3FET-10-T3	1.322,00	C4FET-10-T3	1.738,00
12,5 CV	C1FET-12,5-T3	620,00	C2FET-12,5-T3	996,00	C3FET-12,5-T3	1.392,00	C4FET-12,5-T3	1.893,00
15 CV	C1FET-15-T3	691,00	C2FET-15-T3	1.110,00	C3FET-15-T3	1.578,00	C4FET-15-T3	2.094,00
20 CV	C1FET-20-T3	841,00	C2FET-20-T3	1.368,00	C3FET-20-T3	2.131,00	C4FET-20-T3	2.894,00
25 CV	C1FET-25-T3	863,00	C2FET-25-T3	1.532,00	C3FET-25-T3	2.231,00	C4FET-25-T3	3.171,00
30 CV	C1FET-30-T3	945,00	C2FET-30-T3	1.637,00	C3FET-30-T3	2.445,00	C4FET-30-T3	3.490,00
40 CV	C1FET-40-T3	1.076,00	C2FET-40-T3	1.966,00	C3FET-40-T3	3.063,00	C4FET-40-T3	4.103,00
50 CV	C1FET-50-T3	1.262,00	C2FET-50-T3	2.441,00	C3FET-50-T3	3.687,00	C4FET-50-T3	4.970,00
60 CV	C1FET-60-T3	1.375,00	C2FET-60-T3	2.917,00	C3FET-60-T3	3.787,00	C4FET-60-T3	5.165,00

**INCORPORAN ALARMA ACÚSTICA Y VISUAL DE SERIE
INCLUDE ACOUSTIC AND VISUAL ALARM AS A STANDARD**



CUADROS ELÉCTRICOS CON ARRANCADORES PROGRESIVOS EQUIPOS DE PRESIÓN

Cuadros Trifásicos a 400 V

C.V.	CUADROS DE 1 BOMBA		CUADROS DE 2 BOMBAS		CUADROS DE 3 BOMBAS		CUADROS DE 4 BOMBAS	
	Referencia	P.V.P.	Referencia	P.V.P.	Referencia	P.V.P.	Referencia	P.V.P.
3 CV	C1PAR-3-T3	652,00	C2PAR-3-T3	1.147,00	C3PAR-3-T3	1.658,00	C4PAR-3-T3	2.158,00
4 CV	C1PAR-4-T3	652,00	C2PAR-4-T3	1.147,00	C3PAR-4-T3	1.659,00	C4PAR-4-T3	2.165,00
5,5 CV	C1PAR-5,5-T3	652,00	C2PAR-5,5-T3	1.153,00	C3PAR-5,5-T3	1.675,00	C4PAR-5,5-T3	2.168,00
7,5 CV	C1PAR-7,5-T3	651,00	C2PAR-7,5-T3	1.151,00	C3PAR-7,5-T3	1.679,00	C4PAR-7,5-T3	2.218,00
10 CV	C1PAR-10-T3	744,00	C2PAR-10-T3	1.353,00	C3PAR-10-T3	1.987,00	C4PAR-10-T3	2.581,00
12,5 CV	C1PAR-12,5-T3	764,00	C2PAR-12,5-T3	1.400,00	C3PAR-12,5-T3	2.076,00	C4PAR-12,5-T3	2.665,00
15 CV	C1PAR-15-T3	778,00	C2PAR-15-T3	1.449,00	C3PAR-15-T3	2.134,00	C4PAR-15-T3	2.722,00
20 CV	C1PAR-20-T3	904,00	C2PAR-20-T3	1.655,00	C3PAR-20-T3	2.488,00	C4PAR-20-T3	3.136,00
25 CV	C1PAR-25-T3	1.136,00	C2PAR-25-T3	2.173,00	C3PAR-25-T3	3.172,00	C4PAR-25-T3	4.268,00
30 CV	C1PAR-30-T3	1.481,00	C2PAR-30-T3	2.828,00	C3PAR-30-T3	4.254,00	C4PAR-30-T3	5.727,00

CUADROS ELÉCTRICOS CON ARRANCADORES PROGRESIVO AGUAS SUCIAS

Cuadros Trifásicos a 400 V

C.V.	CUADROS DE 1 BOMBA		CUADROS DE 2 BOMBAS		CUADROS DE 3 BOMBAS		CUADROS DE 4 BOMBAS	
	Referencia	P.V.P.	Referencia	P.V.P.	Referencia	P.V.P.	Referencia	P.V.P.
3 CV	C1FAR-3-T3	690,00	C2FAR-3-T3	1.194,00	C3FAR-3-T3	1.720,00	C4FAR-3-T3	2.233,00
4 CV	C1FAR-4-T3	690,00	C2FAR-4-T3	1.194,00	C3FAR-4-T3	1.720,00	C4FAR-4-T3	2.239,00
5,5 CV	C1FAR-5,5-T3	690,00	C2FAR-5,5-T3	1.197,00	C3FAR-5,5-T3	1.739,00	C4FAR-5,5-T3	2.242,00
7,5 CV	C1FAR-7,5-T3	689,00	C2FAR-7,5-T3	1.198,00	C3FAR-7,5-T3	1.743,00	C4FAR-7,5-T3	2.292,00
10 CV	C1FAR-10-T3	781,00	C2FAR-10-T3	1.399,00	C3FAR-10-T3	2.047,00	C4FAR-10-T3	2.656,00
12,5 CV	C1FAR-12,5-T3	802,00	C2FAR-12,5-T3	1.446,00	C3FAR-12,5-T3	2.135,00	C4FAR-12,5-T3	2.740,00
15 CV	C1FAR-15-T3	816,00	C2FAR-15-T3	1.495,00	C3FAR-15-T3	2.196,00	C4FAR-15-T3	2.796,00
20 CV	C1FAR-20-T3	940,00	C2FAR-20-T3	1.702,00	C3FAR-20-T3	2.552,00	C4FAR-20-T3	3.211,00
25 CV	C1FAR-25-T3	1.174,00	C2FAR-25-T3	2.219,00	C3FAR-25-T3	3.235,00	C4FAR-25-T3	4.286,00
30 CV	C1FAR-30-T3	1.514,00	C2FAR-30-T3	2.857,00	C3FAR-30-T3	4.283,00	C4FAR-30-T3	5.756,00

CUADROS VARIO SYSTEM CON VARIADOR DE FRECUENCIA

CUADROS VARIO 1 BOMBA (Sin Función Presostatos)			
Referencia	C.V.	Int. Máx.	P.V.P.
C1VF-1,5-T3	1,5	3,4 A	1.298,00
C1VF-2-T3	2	4,1 A	1.469,00
C1VF-3-T3	3	5,7 A	1.538,00
C1VF-4-T3	4	7,3 A	1.640,00
C1VF-5,5-T3	5,5	9,5 A	1.827,00
C1VF-7,5-T3	7,5	12,7 A	2.004,00
C1VF-10-T3	10	18 A	2.367,00
C1VF-15-T3	15	26 A	2.671,00
C1VF-20-T3	20	33 A	3.299,00
C1VF-25-T3	25	39 A	3.821,00
C1VF-30-T3	30	46 A	4.390,00
C1VF-40-T3	40	62 A	5.279,00
C1VF-50-T3	50	73 A	6.226,00

CUADROS VARIO 2 BOMBAS ALTERNADAS			
Referencia	C.V.	Int. Máx.	P.V.P.
C2VF-1,5-T3A	1,5	3,4 A	1.710,00
C2VF-2-T3A	2	4,1 A	1.881,00
C2VF-3-T3A	3	5,7 A	1.951,00
C2VF-4-T3A	4	7,3 A	2.054,00
C2VF-5,5-T3A	5,5	9,5 A	2.254,00
C2VF-7,5-T3A	7,5	12,7 A	3.001,00
C2VF-10-T3A	10	18 A	3.373,00
C2VF-15-T3A	15	26 A	3.906,00
C2VF-20-T3A	20	33 A	4.990,00
C2VF-25-T3A	25	39 A	5.527,00
C2VF-30-T3A	30	46 A	6.443,00
C2VF-40-T3A	40	62 A	7.570,00
C2VF-50-T3A	50	73 A	9.040,00

CUADROS VARIO 3 BOMBAS ALTERNADAS			
Referencia	C.V.	Int. Máx.	P.V.P.
C3VF-1,5-T3A	1,5	3,4 A	2.282,00
C3VF-2-T3A	2	4,1 A	2.455,00
C3VF-3-T3A	3	5,7 A	2.524,00
C3VF-4-T3A	4	7,3 A	2.632,00
C3VF-5,5-T3A	5,5	9,5 A	2.845,00
C3VF-7,5-T3A	7,5	12,7 A	3.573,00
C3VF-10-T3A	10	18 A	4.102,00
C3VF-15-T3A	15	26 A	4.733,00
C3VF-20-T3A	20	33 A	6.470,00
C3VF-25-T3A	25	39 A	7.023,00
C3VF-30-T3A	30	46 A	8.048,00
C3VF-40-T3A	40	62 A	9.137,00
C3VF-50-T3A	50	73 A	10.870,00

CUADROS VARIO 4 BOMBAS ALTERNADAS			
Referencia	C.V.	Int. Máx.	P.V.P.
C4VF-1,5-T3A	1,5	3,4 A	2.867,00
C4VF-2-T3A	2	4,1 A	3.039,00
C4VF-3-T3A	3	5,7 A	3.111,00
C4VF-4-T3A	4	7,3 A	3.221,00
C4VF-5,5-T3A	5,5	9,5 A	3.436,00
C4VF-7,5-T3A	7,5	12,7 A	4.537,00
C4VF-10-T3A	10	18 A	4.851,00
C4VF-15-T3A	15	26 A	5.615,00
C4VF-20-T3A	20	33 A	7.099,00
C4VF-25-T3A	25	39 A	7.714,00
C4VF-30-T3A	30	46 A	10.731,00
C4VF-40-T3A	40	62 A	11.826,00
C4VF-50-T3A	50	73 A	13.981,00

CUADROS VARIO SYSTEM ALTERNADOS

CUADROS VARIO SYSTEM MULTIMASTER

CUADROS TRIFÁSICOS A 400V



CUADRO VARIO 2 BOMBAS MULTIMASTER			
Referencia	C.V.	Int. Máx.	P.V.P.
C2VF-1,5-T3MM	1,5	3,4 A	2.258,00
C2VF-2-T3MM	2	4,1 A	2.361,00
C2VF-3-T3MM	3	5,7 A	2.472,00
C2VF-4-T3MM	4	7,3 A	2.611,00
C2VF-5,5-T3MM	5,5	9,5 A	2.946,00
C2VF-7,5-T3MM	7,5	12,7 A	3.213,00
C2VF-10-T3MM	10	18 A	3.927,00
C2VF-15-T3MM	15	26 A	4.645,00
C2VF-20-T3MM	20	33 A	5.767,00
C2VF-25-T3MM	25	39 A	6.832,00
C2VF-30-T3MM	30	46 A	7.870,00
C2VF-40-T3MM	40	62 A	CONSULTAR
C2VF-50-T3MM	50	73 A	CONSULTAR

CUADRO VARIO 3 BOMBAS MULTIMASTER			
Referencia	C.V.	Int. Máx.	P.V.P.
C3VF-1,5-T3MM	1,5	3,4 A	3.266,00
C3VF-2-T3MM	2	4,1 A	3.423,00
C3VF-3-T3MM	3	5,7 A	3.591,00
C3VF-4-T3MM	4	7,3 A	3.803,00
C3VF-5,5-T3MM	5,5	9,5 A	4.307,00
C3VF-7,5-T3MM	7,5	12,7 A	4.703,00
C3VF-10-T3MM	10	18 A	5.803,00
C3VF-15-T3MM	15	26 A	6.874,00
C3VF-20-T3MM	20	33 A	8.570,00
C3VF-25-T3MM	25	39 A	10.081,00
C3VF-30-T3MM	30	46 A	11.755,00
C3VF-40-T3MM	40	62 A	CONSULTAR
C3VF-50-T3MM	50	73 A	CONSULTAR

CUADRO VARIO 4 BOMBAS MULTIMASTER			
Referencia	C.V.	Int. Máx.	P.V.P.
C4VF-1,5-T3MM	1,5	3,4 A	CONSULTAR
C4VF-2-T3MM	2	4,1 A	CONSULTAR
C4VF-3-T3MM	3	5,7 A	CONSULTAR
C4VF-4-T3MM	4	7,3 A	CONSULTAR
C4VF-5,5-T3MM	5,5	9,5 A	CONSULTAR
C4VF-7,5-T3MM	7,5	12,7 A	CONSULTAR
C4VF-10-T3MM	10	18 A	CONSULTAR
C4VF-15-T3MM	15	26 A	CONSULTAR
C4VF-20-T3MM	20	33 A	CONSULTAR
C4VF-25-T3MM	25	39 A	CONSULTAR
C4VF-30-T3MM	30	46 A	CONSULTAR
C4VF-40-T3MM	40	62 A	CONSULTAR
C4VF-50-T3MM	50	73 A	CONSULTAR

**EL PRECIO INCLUYE TRANSDUCTOR DE PRESION 4-20mA 0-10 Bar
THE PRICE INCLUDES PRESSURE TRANSDUCER 4-20mA 0-10 Bar**

TIPO
TYPE

PVP €

CUADROS CONTRAINCENDIOS MULTINORMA CON JOCKEY ELECTRICOS A 400V



** Las bombas jockey siempre son con arranque directo.

** En el momento de pasar el pedido rogamos especifique consumo (A) de la bomba jockey.

ANEXO C 3CV + JOCKEY 1,3CV	685,00
ANEXO C 4CV + JOCKEY 1,3CV	685,00
ANEXO C 5,5CV + JOCKEY 3CV	685,00
ANEXO C 7,5CV + JOCKEY 4CV	716,00
ANEXO C 10CV + JOCKEY 5,5CV	695,00
MULTINORMA 7,5CV (DIR) + JOCKEY 4CV	1.131,00
MULTINORMA 7,5CV + JOCKEY 1,7CV	1.294,00
MULTINORMA 7,5CV + JOCKEY 2CV	1.300,00
MULTINORMA 10CV (DIR) + JOCKEY 5,5CV	1.153,00
MULTINORMA 10CV + JOCKEY 1,7CV	1.296,00
MULTINORMA 10CV + JOCKEY 2CV	1.302,00
MULTINORMA 12,5CV + JOCKEY 1,7CV	1.330,00
MULTINORMA 15CV + JOCKEY 1,7CV	1.361,00
MULTINORMA 15CV + JOCKEY 3CV	1.368,00
MULTINORMA 20CV + JOCKEY 2CV	1.445,00
MULTINORMA 20CV + JOCKEY 3CV	1.452,00
MULTINORMA 25CV + JOCKEY 3CV	1.758,00
MULTINORMA 30CV + JOCKEY 3CV	1.826,00
MULTINORMA 40CV + JOCKEY 3CV	1.928,00
MULTINORMA 50CV + JOCKEY 3CV	2.105,00
MULTINORMA 60CV + JOCKEY 3CV	2.213,00
MULTINORMA 75CV + JOCKEY 4CV	2.319,00
MULTINORMA 100CV + JOCKEY 3CV	2.926,00
MULTINORMA 125CV + JOCKEY 3CV	3.267,00
MULTINORMA 150CV + JOCKEY 5,5CV	3.612,00

TIPO
TYPE

PVP €

CUADROS DIESEL CEPREVEN / UNE 2012 / EN-12845



** Las bombas jockey siempre son con arranque directo.

** En el momento de pasar el pedido rogamos especifique consumo (A) de la bomba jockey.

CUADRO DIESEL CEPREVEN / UNE 2012 / EN12845 12V	1.810,00
CUADRO DIESEL CEPREVEN / UNE 2012 / EN12485 24V	1.810,00
CUADRO ARRANQUE EMERG. CEPREV./UNE2012/EN12845 12V	489,00
CUADRO ARRANQUE EMERG. CEPREV./UNE2012/EN12845 24V	536,00
CUADRO CEPR/UNE012/EN12845 SOLO JOCKEY HASTA 5,5CV	778,00

CUADROS DIESEL UNE 2018

CUADRO DIESEL UNE 2018 12V (PARA BIES)	1.556,00
CUADRO DIESEL UNE 2018 12V (ABST. SUPERIOR)	1.874,00
CUADRO DIESEL UNE 2018 24V (ABST. SUPERIOR)	1.874,00
CUADRO ARRANQUE EMERG. UNE2018 12V	540,00
CUADRO ARRANQUE EMERG. UNE2018 24V	587,00
CUADRO SOLO JOCKEY UNE 2018 HASTA 5.5CV	778,00

PARA CUADROS DE OTRAS NORMATIVAS, CONSULTEN NUESTRO DEPARTAMENTO COMERCIAL

CUADROS ELÉCTRICOS PARA PISCINAS



Cuadros Electrónicos para Piscinas

Referencia	P.V.P.
SMART POOL COMPLETO (PARED / WALL)	230,00
CUADRO (PANEL) FOCOS LED 50W	90,00
CUADRO (PANEL) FOCOS LED 2x50W	160,00
SONDA (PROBE) TEMPERATURA PT-100 1/4" AISI 316	67,00

Cuadros Monofásicos

C.V.	CUADROS SIMPLES		CUADROS 1 TRANSF.		CUADROS 2 TRANSF.		CUADROS 3 TRANSF.	
	Referencia	P.V.P.	Referencia	P.V.P.	Referencia	P.V.P.	Referencia	P.V.P.
0,25 CV	CPI-S-0,25-M	212,00	CPI-1TR-0,25-M	363,00	CPI-2TR-0,25-M	431,00	CPI-3TR-0,25-M	589,00
0,33 CV	CPI-S-0,33-M	212,00	CPI-1TR-0,33-M	363,00	CPI-2TR-0,33-M	431,00	CPI-3TR-0,33-M	589,00
0,5 CV	CPI-S-0,5-M	212,00	CPI-1TR-0,5-M	363,00	CPI-2TR-0,5-M	432,00	CPI-3TR-0,5-M	590,00
0,75 CV	CPI-S-0,75-M	212,00	CPI-1TR-0,75-M	363,00	CPI-2TR-0,75-M	432,00	CPI-3TR-0,75-M	590,00
1 CV	CPI-S-1-M	212,00	CPI-1TR-1-M	363,00	CPI-2TR-1-M	432,00	CPI-3TR-1-M	590,00
1,5 CV	CPI-S-1,5-M	212,00	CPI-1TR-1,5-M	363,00	CPI-2TR-1,5-M	432,00	CPI-3TR-1,5-M	590,00
2 CV	CPI-S-2-M	235,00	CPI-1TR-2-M	369,00	CPI-2TR-2-M	455,00	CPI-3TR-2-M	613,00

*1 TRANSFORMADOR = 350 W

*2 TRANSFORMADORES = 700 W

*3 TRANSFORMADORES = 700 W + 350 W

Cuadros Trifásicos a 400 V

C.V.	CUADROS SIMPLES		CUADROS 1 TRANSF.		CUADROS 2 TRANSF.		CUADROS 3 TRANSF.	
	Referencia	P.V.P.	Referencia	P.V.P.	Referencia	P.V.P.	Referencia	P.V.P.
0,5 CV	CPI-S-0,5-T3	214,00	CPI-1TR-0,5-T3	364,00	CPI-2TR-0,5-T3	433,00	CPI-3TR-0,5-T3	591,00
0,75 CV	CPI-S-0,75-T3	214,00	CPI-1TR-0,75-T3	364,00	CPI-2TR-0,75-T3	433,00	CPI-3TR-0,75-T3	591,00
1 CV	CPI-S-1-T3	214,00	CPI-1TR-1-T3	364,00	CPI-2TR-1-T3	433,00	CPI-3TR-1-T3	591,00
1,5 CV	CPI-S-1,5-T3	215,00	CPI-1TR-1,5-T3	365,00	CPI-2TR-1,5-T3	434,00	CPI-3TR-1,5-T3	592,00
2 CV	CPI-S-2-T3	215,00	CPI-1TR-2-T3	365,00	CPI-2TR-2-T3	434,00	CPI-3TR-2-T3	592,00
3 CV	CPI-S-3-T3	215,00	CPI-1TR-3-T3	365,00	CPI-2TR-3-T3	434,00	CPI-3TR-3-T3	592,00
4 CV	CPI-S-4-T3	215,00	CPI-1TR-4-T3	365,00	CPI-2TR-4-T3	434,00	CPI-3TR-4-T3	592,00
5,5 CV	CPI-S-5,5-T3	221,00	CPI-1TR-5,5-T3	371,00	CPI-2TR-5,5-T3	440,00	CPI-3TR-5,5-T3	598,00

*1 TRANSFORMADOR = 350 W

*2 TRANSFORMADORES = 700 W

*3 TRANSFORMADORES = 700 W + 350 W

Cuadros Trifásicos a 400 V



CUADROS CONTROL BOMBA + BATERIA DE VALVULAS		P.V.P.
Referencia		
	CUADRO PISCINA PUBLICA (4 VALVULAS) ARR. DIRECTO	1.794,00
	CUADRO PISCINA PUBLICA (5 VALVULAS) ARR. DIRECTO	1.849,00
	CUADRO PISCINA PUBLICA (4 VALVULAS) ARR. ESTRELLA-TRIANGULO	2.016,00
	CUADRO PISCINA PUBLICA (5 VALVULAS) ARR. ESTRELLA-TRIANGULO	2.074,00

CUADROS BOMBAS SUMERGIBLES



CUADROS DIGITALES SIN SONDAS

C.V.	CUADROS DIGITALES SIN SONDAS		
	Amparaje	Referencia	P.V.P.
0,5-2 CV		CUADRO DIGITAL MASICO 0,5 - 2 CV	232,00
0,5-5,5 CV		CUADRO DIGITAL TRIFASICO 0,5 - 5,5 CV	245,00

CUADROS CON SONDAS MONOFÁSICOS

C.V.	CUADROS CON SONDAS POZO		
	Amparaje	Referencia	P.V.P.
0,75-1 CV	4 - 6 A	CSP - 1 - M	144,00
1,5 CV	7 - 10 A	CSP - 1,5 - M	144,00
2 CV	9 - 13 A	CSP - 2 - M	144,00

CUADROS SIN SONDAS MONOFÁSICOS

C.V.	CUADROS SOLO PROTECCIÓN BOMBA		
	Amparaje	Referencia	P.V.P.
1	4 - 6 A	CS-1-M	91,00
1,5	7 - 10 A	CS-1,5-M	91,00
2	9 - 13 A	CS-2-M	91,00

CUADROS CON SONDAS TRIFÁSICOS A 400 V

C.V.	CUADROS CON SONDAS POZO		
	Amparaje	Referencia	P.V.P.
0,75-1 CV	1,6 - 2,5 A	CSP - 1 - T3	157,00
1,5 - 2 CV	2,5 - 4 A	CSP - 2 - T3	157,00
3 - 4 CV	5,5 - 8 A	CSP - 4 - T3	157,00
5,5 CV	9 - 13 A	CSP - 5,5 - T3	157,00

CUADROS SIN SONDAS TRIFÁSICOS A 400 V

C.V.	CUADROS SOLO PROTECCIÓN BOMBA		
	Amparaje	Referencia	P.V.P.
1	1,6 - 2,5 A	CS-1-T3	102,00
2	2,5 - 4 A	CS-2-T3	102,00
4	5,5 - 8 A	CS-4-T3	102,00
5,5	9 - 13 A	CS-5,5-T3	102,00

SUPLEMENTOS OPCIONALES PARA CUADROS ELECTRICOS

ESTOS SUPLEMENTOS NUNCA SERÁN APLICABLES SOBRE LA SERIE DE CUADROS CSP

En caso de incluir más de un suplemento por cuadro rogamos consulten nuestro Departamento Técnico.

Descripción	P.V.P.
Suplemento Protección Secuencia y Fallo de Fases	95,00
Suplemento Reloj Horario para Control de Electroválvulas	116,00
Suplemento Arranque por señal Externa de Programador	51,00
Suplemento Sondas Pozo (incluye relé más 3 sondas pozo)	117,00
Suplemento Sondas Pozo-Depósito (incluye relé más 6 sondas pozo)	213,00

* Su coste varía según el modelo de cuadro solicitado, rogamos consulten.

OTROS SUPLEMENTO ROGAMOS CONSULTEN NUESTRO DEPT. TÉCNICO



BARCELONA

C./ Can Muntanyola, 4-22
Pol. Ind. Palou Nord
08401 Granollers, Barcelona - Spain
Tel. +34 93 384 23 51
saci@sacipumps.com

A CORUÑA

Poligono Pocomaco, Parcela D-31
15190 A CORUÑA - Spain
Tel. +34 981 29 96 88
sacicoruna@sacipumps.com

LEVANTE

C/ Mónaco, Nave 39
Pol. Ind. Ciudad del Transporte II
Tel. +34 964 33 44 66
sacilevante@sacipumps.com

www.sacipumps.com



TIPO TYPE	CV HP	PVP € Bomba/Pump Optima	PVP € con cuadro/with panel Smart Optima
--------------	----------	-------------------------------	--

OPTIMA - AUTOASPIRANTES PARA PISCINAS



OPTIMA 25 M	0,25	287,00	506,00
OPTIMA 25 T	0,25	287,00	-
OPTIMA 33 M	0,33	287,00	506,00
OPTIMA 33 T	0,33	287,00	-
OPTIMA 50 M	0,5	305,00	524,00
OPTIMA 50 T	0,5	305,00	-
OPTIMA 75 M	0,75	314,00	533,00
OPTIMA 75 T	0,75	314,00	-
OPTIMA 100 M	1	347,00	566,00
OPTIMA 100 T	1	347,00	-
OPTIMA 150 M	1,5	399,00	618,00
OPTIMA 150 T	1,5	399,00	-

KIT SOPORTE PARED SMART POOL

22,00

TIPO TYPE	CV HP	PVP € Bomba/Pump Winner	PVP € con cuadro/with panel Smart Winner	PVP € con variador with inverter VSD Winner
--------------	----------	-------------------------------	--	--

WINNER - AUTOASPIRANTES PARA PISCINAS



WINNER 50 M	0,5	340,00	559,00	1.099,00
WINNER 50 T	0,5	340,00	-	-
WINNER 75 M	0,75	363,00	582,00	1.122,00
WINNER 75 T	0,75	363,00	-	-
WINNER 100 M	1	402,00	621,00	1.161,00
WINNER 100 T	1	402,00	-	-
WINNER 150 M	1,5	438,00	657,00	1.197,00
WINNER 150 T	1,5	438,00	-	-
WINNER 200 M	2	514,00	733,00	1.273,00
WINNER 200 T	2	514,00	-	-
WINNER 300 M	3	604,00	823,00	1.312,00
WINNER 300 T	3	553,00	-	-

KIT SOPORTE PARED SMART POOL

22,00

KIT SOPORTE PARED [e]JOY

79,00

* Las bombas VSD WINNER incorporan el variador [e]JOY MT2

* The VSD WINNER pumps includes the [e]JOY MT2 inverter

TIPO TYPE	CV HP	PVP €
--------------	----------	-------



CUADRO ELÉCTRICO PARA BOMBAS DE PISCINA

SMART POOL COMPLETO (PARED / WALL)		230,00
CUADRO (PANEL) FOCOS LED 50W		90,00
CUADRO (PANEL) FOCOS LED 2x50W		160,00
SONDA (PROBE) TEMPERATURA PT-100 1/4" AISI 316		67,00

	TIPO TYPE	CV HP	PVP €
--	--------------	----------	-------



[e]WINNER - VELOCIDAD VARIABLE CON MOTOR DE IMANES PERMANENTES

[e]WINNER 300 M IE5	MAX 3 HP	1.615,00
SOPORTE PARED VARIADOR		79,00



SUPRA - AUTOASPIRANTES PARA PISCINAS

SUPRA 300 - 2900 RPM	3	885,00
SUPRA 400 - 2900 RPM	4	942,00
SUPRA 550 - 2900 RPM	5,5	1.116,00



BRAVUS - CENTRIFUGAS CONTRA CORRIENTE

BRAVUS 300 - 2900 RPM	3	809,00
BRAVUS 400 - 2900 RPM	4	863,00
BRAVUS 550 - 2900 RPM	5,5	1.038,00

	TIPO TYPE	CV HP	PVP € Bomba/Pump Magnus	PVP € con variador with inverter VSD Magnus
--	--------------	----------	-------------------------------	--



MAGNUS - AUTOASPIRANTES PARA PISCINAS

MAGNUS-4 250	2,5	1.163,00	1.958,00
MAGNUS-4 300	3	1.163,00	1.958,00
MAGNUS-4 400	4	1.191,00	1.986,00
MAGNUS-4 550	5,5	1.330,00	2.125,00
MAGNUS-4 550 (Rod. BRONCE)	5,5	1.700,00	2.495,00
MAGNUS-4 750	7,5	1.801,00	3.391,00
MAGNUS-4 750 (Rod. BRONCE)	7,5	2.137,00	3.727,00
MAGNUS-4 1000	10	1.853,00	3.443,00
MAGNUS-4 1000 (Rod. BRONCE)	10	2.177,00	3.767,00
MAGNUS-2 1250	12,5	2.203,00	3.793,00
MAGNUS-2 1500	15	2.230,00	3.820,00

BOMBAS A 1.450RPM EXCEPTO
MODELOS DE 12,5CV Y 15CV
PUMPS AT 1,450RPM EXCEPT
THE 12,5HP AND 15HP TYPES

KIT CONTRABRIDAS PVC DN-110

114,00

* Las bombas VSD MAGNUS incorporan el variador [e]POOL TT3

* The VSD MAGNUS pumps includes the [e]POOL TT3 inverter

	TIPO TYPE	CV HP	PVP € Bomba Pump
--	--------------	----------	------------------------



[e]MAGNUS BOMBA PISCINA VELOCIDAD VARIABLE CON MOTOR DE IMANES PERMANENTES

[e]MAGNUS-4 550 IE5	5,5	2.934,00
[e]MAGNUS-4 550 (ROD. BRONCE) IE5	5,5	3.357,00
SOPORTE PARED VARIADOR		79,00

	TIPO TYPE	CV HP	PVP € Bomba Pump
--	--------------	----------	------------------------

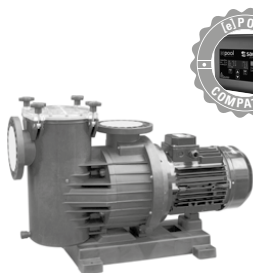

HF-2 MAGNUS - ALTA PRESIÓN 2.850 RPM

HF-2 MAGNUS-4 558	5,5	CONSULTAR
HF-2 MAGNUS-4 558 (ROD. BRONCE)	5,5	CONSULTAR
HF-2 MAGNUS-4 758	7,5	CONSULTAR
HF-2 MAGNUS-4 758 (ROD. BRONCE)	7,5	CONSULTAR
HF-2 MAGNUS-4 1008	10	1.912,00
HF-2 MAGNUS-4 1008 (ROD. BRONCE)	10	CONSULTAR
KIT CONTRABRIDAS PVC DN-110		114,00



VERT MAGNUS AUTOASPIRANTES VERTICALES PISCINAS

VERT MAGNUS-4 250	2,5	4.163,00
VERT MAGNUS-4 300	3	4.163,00
VERT MAGNUS-4 400	4	4.203,00
VERT MAGNUS-4 550	5,5	4.365,00
VERT MAGNUS-4 550 (ROD. BRONCE)	5,5	4.752,00
VERT MAGNUS-4 750	7,5	4.555,00
VERT MAGNUS-4 750 (ROD. BRONCE)	7,5	4.945,00
VERT MAGNUS-4 1000	10	4.739,00
VERT MAGNUS-4 1000 (ROD. BRONCE)	10	5.137,00
VERT MAGNUS-2 1250	12,5	5.220,00
VERT MAGNUS-2 1500	15	5.265,00

	TIPO TYPE	CV HP	PVP € Bomba/Pump Kontra	PVP € con variador with inverter VSD Kontra
--	--------------	----------	-------------------------------	--



KONTRA - CENTRIFUGAS DE GRAN CAUDAL (CONTRACORRIENTE)

KONTRA-4 250	2,5	978,00	1.773,00
KONTRA-4 300	3	978,00	1.773,00
KONTRA-4 400	4	1.004,00	1.799,00
KONTRA-4 550	5,5	1.147,00	1.942,00
KONTRA-4 550 (ROD. BRONCE)	5,5	1.516,00	2.311,00
KONTRA-4 750	7,5	1.608,00	3.198,00
KONTRA-4 750 (ROD. BRONCE)	7,5	1.943,00	3.533,00
KONTRA-4 1000	10	1.653,00	3.243,00
KONTRA-4 1000 (ROD. BRONCE)	10	1.978,00	3.568,00
KONTRA-2 1250	12,5	2.004,00	3.594,00
KONTRA-2 1500	15	2.030,00	3.620,00
KIT CONTRABRIDAS PVC DN-110		114,00	

BOMBAS A 1.450RPM EXCEPTO
MODELOS DE 12,5CV Y 15CV
PUMPS AT 1,450RPM EXCEPT
THE 12,5HP AND 15HP TYPES

* Las bombas VSD KONTRA incorporan el variador [e]POOL TT3
* The VSD KONTRA pumps includes the [e]POOL TT3 inverter

	TIPO TYPE	PVP €
--	--------------	-------



VARIADORES DE FRECUENCIA PARA BOMBAS DE PISCINA

VARIADOR DE VELOCIDAD [e]JOY (MT2)	640,00
VARIADOR DE VELOCIDAD [e]POOL (TT3-11)	832,00
VARIADOR DE VELOCIDAD [e]POOL (TT3-30)	1.650,00
SONDA TEMPERATURA NTC 47K B=4000 1/4" AISI 316	74,00
SOPORTE PARED VARIADOR [e]JOY - [e]POOL	79,00

	TIPO TYPE	CV HP	PVP € Motor IE-3
--	--------------	----------	---------------------



2.900 r.p.m.

CF-2 - 2,900 RPM

CF-2 300 (2.900 r.p.m.)	3	1.582,00
CF-2 400 (2.900 r.p.m.)	4	1.724,00
CF-2 550 (2.900 r.p.m.)	5,5	2.057,00
CF-2 551 (2.900 r.p.m.)	5,5	2.061,00
CF-2 750 (2.900 r.p.m.)	7,5	2.315,00
CF-2 1000 (2.900 r.p.m.)	10	2.639,00
CF-2 1250 (2.900 r.p.m.)	12,5	2.971,00
CF-2 1500 (2.900 r.p.m.)	15	3.120,00



2.900 r.p.m.

HF-2 GRAN ALTURA A 2,900 RPM

HF-2 308 (2.900 r.p.m.)	3	2.269,00
HF-2 408 (2.900 r.p.m.)	4	2.426,00
HF-2 558 (2.900 r.p.m.)	5,5	2.515,00
HF-2 758 (2.900 r.p.m.)	7,5	3.061,00
HF-2 1008 (2.900 r.p.m.)	10	3.376,00
HF-2 1208 (2.900 r.p.m.)	10	3.346,00
HF-2 1508 (2.900 r.p.m.)	15	4.008,00
HF-2 2008 (2.900 r.p.m.)	20	4.253,00
HF-2 2508 (2.900 r.p.m.)	25	4.483,00



2.900 r.p.m.

VERT CF-2 VERTICAL A 2,900 RPM

VERT CF-2 300 (2.900 r.p.m.)	3	2.622,00
VERT CF-2 400 (2.900 r.p.m.)	4	2.700,00
VERT CF-2 550 (2.900 r.p.m.)	5,5	2.998,00
VERT CF-2 551 (2.900 r.p.m.)	5,5	3.005,00
VERT CF-2 750 (2.900 r.p.m.)	7,5	3.287,00
VERT CF-2 1000 (2.900 r.p.m.)	10	3.571,00
VERT CF-2 1250 (2.900 r.p.m.)	12,5	3.799,00
VERT CF-2 1500 (2.900 r.p.m.)	15	3.948,00



2.900 r.p.m.

VERT HF-2 VERTICALES PARA GRAN ALTURA A 2,900 RPM

VERT HF-2 308 (2.900 r.p.m.)	3	3.047,00
VERT HF-2 408 (2.900 r.p.m.)	4	3.205,00
VERT HF-2 558 (2.900 r.p.m.)	5,5	3.293,00
VERT HF-2 758 (2.900 r.p.m.)	7,5	3.839,00
VERT HF-2 1008 (2.900 r.p.m.)	10	4.154,00
VERT HF-2 1208 (2.900 r.p.m.)	10	4.125,00
VERT HF-2 1508 (2.900 r.p.m.)	15	4.789,00
VERT HF-2 2008 (2.900 r.p.m.)	20	5.021,00
VERT HF-2 2508 (2.900 r.p.m.)	25	5.251,00

TIPO
TYPE

CV
HP

PVP €
Motor IE-3



CF-4 CON PREFILTRO A 1,450 RPM



1.450 r.p.m.

CF-4 300	(1.450 r.p.m.)	3	2.476,00
CF-4 400	(1.450 r.p.m.)	4	2.771,00
CF-4 550	(1.450 r.p.m.)	5,5	2.902,00
CF-4 552	(1.450 r.p.m.)	5,5	3.220,00
CF-4 750	(1.450 r.p.m.)	7,5	3.458,00
CF-4 1000	(1.450 r.p.m.)	10	3.956,00
CF-4 1500	(1.450 r.p.m.)	15	5.166,00
CF-4 2000	(1.450 r.p.m.)	20	5.980,00
CF-4 2500	(1.450 r.p.m.)	25	6.525,00



HF-4 CON PREFILTRO GRAN ALTURA A 1,450 RPM



1.450 r.p.m.

HF-4 308	(1.450 r.p.m.)	3	2.879,00
HF-4 408	(1.450 r.p.m.)	4	2.913,00
HF-4 558	(1.450 r.p.m.)	5,5	3.131,00
HF-4 758	(1.450 r.p.m.)	7,5	3.934,00
HF-4 1008	(1.450 r.p.m.)	10	4.548,00
HF-4 1508	(1.450 r.p.m.)	15	5.378,00
HF-4 2008	(1.450 r.p.m.)	20	5.694,00
HF-4 2508	(1.450 r.p.m.)	25	6.502,00
HF-4 3008	(1.450 r.p.m.)	30	6.790,00



VERT CF-4 CON PREFILTRO VERTICAL A 1,450 RPM



1.450 r.p.m.

VERT CF-4 300	(1.450 r.p.m.)	3	3.341,00
VERT CF-4 400	(1.450 r.p.m.)	4	3.652,00
VERT CF-4 550	(1.450 r.p.m.)	5,5	3.788,00
VERT CF-4 552	(1.450 r.p.m.)	5,5	4.109,00
VERT CF-4 750	(1.450 r.p.m.)	7,5	4.358,00
VERT CF-4 1000	(1.450 r.p.m.)	10	4.871,00
VERT CF-4 1500	(1.450 r.p.m.)	15	6.136,00
VERT CF-4 2000	(1.450 r.p.m.)	20	6.419,00
VERT CF-4 2500	(1.450 r.p.m.)	25	6.988,00



VERT HF-4 VERTICALES PARA GRAN ALTURA A 1,450 RPM



1.450 r.p.m.

VERT HF-4 308	(1.450 r.p.m.)	3	3.657,00
VERT HF-4 408	(1.450 r.p.m.)	4	3.689,00
VERT HF-4 558	(1.450 r.p.m.)	5,5	3.908,00
VERT HF-4 758	(1.450 r.p.m.)	7,5	4.714,00
VERT HF-4 1208	(1.450 r.p.m.)	10	5.328,00
VERT HF-4 1508	(1.450 r.p.m.)	15	6.145,00
VERT HF-4 2008	(1.450 r.p.m.)	20	6.456,00
VERT HF-4 2508	(1.450 r.p.m.)	25	7.264,00
VERT HF-4 3008	(1.450 r.p.m.)	30	7.552,00

	TIPO TYPE	CV HP	PVP € Motor IE-3
--	--------------	----------	---------------------



BR-2 - CENTRIFUGAS EN BRONCE MARINO

BR-2 300	3	CONSULTAR
BR-2 400	4	CONSULTAR
BR-2 550	5,5	CONSULTAR
BR-2 551	5,5	CONSULTAR
BR-2 750	7,5	CONSULTAR
BR-2 1000	10	CONSULTAR
BR-2 1250	12,5	CONSULTAR
BR-2 1500	15	CONSULTAR

	TIPO TYPE	Conexiones Connections	PVP € Hierro/Cast iron	PVP € Bronce/Bronze
--	--------------	---------------------------	---------------------------	------------------------



PREFILTROS COMPLETOS HIERRO Y BRONCE

F 65 / 65	DN-65	614,00	-
F 80 / 80	DN-80	614,00	CONSULTAR
F 100 / 100	DN-100	662,00	-
F 125 / 125	DN-125	662,00	CONSULTAR
F 150 / 150	DN-150	1.515,00	-
F 200 / 200	DN-200	1.536,00	-



V 65/65	DN-65	1.776,00	-
V 80/80	DN-80	1.776,00	-
V 100/100	DN-100	1.888,00	-
V 125/125	DN-125	1.888,00	-
V 150/150	DN-150	1.888,00	-

	TIPO TYPE	Conexiones Connections	PVP €
--	--------------	---------------------------	-------

PREFILTROS SUELTOS ACERO INOX. AISI 316L



IH 65 / 65	DN-65	2.094,00
IH 80 / 80	DN-80	2.094,00
IH 100 / 100	DN-100	2.094,00
IH 125 / 125	DN-125	2.094,00
IH 150 / 150	DN-150	2.950,00
IH 200 / 200	DN-200	3.400,00

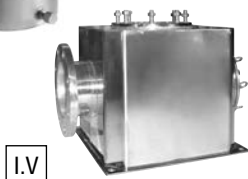

IV 100 / 65 VERT	DN 100-65	2.556,00
IV 100 / 80 VERT	DN 100-80	2.556,00
IV 125 / 100 VERT	DN 125-100	2.556,00
IV 150 / 125 VERT	DN 150-125	3.500,00
IV 200 / 150 VERT	DN 250-150	3.900,00

FILTROS LAMINADOS PISCINA PRIVADA



TIPO TYPE	Ø exterior	Caudal flow lts/h	Ø Ent. Ø Sal.	Arena sand	PVP €
SUN 400	400	6.500	1 1/2"	50 kg.	465,00
SUN 400 (VALV. TOP)	400	6.500	1 1/2"	50 kg.	394,00
SUN 510	510	10.200	1 1/2"	100 kg.	508,00
SUN 510 (VALV. TOP)	510	10.200	1 1/2"	100 kg.	451,00
SUN 620	620	15.100	1 1/2"	150 kg.	568,00
SUN 620 (VALV. TOP)	620	15.100	1 1/2"	150 kg.	508,00
SUN 680	680	18.140	2"	175 kg.	800,00
SUN 680 (VALV. TOP)	680	18.140	2"	175 kg.	561,00
SUN 750	750	22.000	2"	225 kg.	829,00
SUN 900	900	31.800	2"	325 kg.	1.063,00

Filtros de alto rendimiento. No incluyen arena.
High performance filters. Sand not included.



FILTROS LAMINADOS PISCINA PÚBLICA

TIPO TYPE	20 m³/h/m² PVP €	30 m³/h/m² PVP €	40 m³/h/m² PVP €	50 m³/h/m² PVP €
SUN 1050	2.256,00	2.325,00	2.325,00	2.441,00
SUN 1200		2.584,00	2.584,00	2.665,00
SUN 1400	2.707,00	2.852,00	3.241,00	3.241,00
SUN 1600	3.495,00	3.641,00	3.641,00	3.933,00
SUN 1800	4.629,00	4.836,00	5.201,00	5.253,00
SUN 2000	6.035,00	6.235,00	6.705,00	6.839,00

No incluyen batería de válvulas. Lecho filtrante de 1 metro. Incluye brazo colector. Bajo demanda 1,2 mts lecho y placa crepinas.
Battery valves not included. Filtration bed of 1 meter. Includes arm collector. Under demand 1,2 meters of filtration bed and/or Nozzle plate.

SUPLEMENTO BOCA DE HOMBRE

1.132,00

SUPLEMENTO MIRILLA

453,00

FILTROS LAMINADOS ALTO RENDIMIENTO

High performance Laminated Filters



TIPO TYPE	20 m³/h/m² PVP €	30 m³/h/m² PVP €	40 m³/h/m² PVP €	50 m³/h/m² PVP €
FILTRO AR. LAM. SUN D.1050	3.100,00	3.332,00	3.332,00	3.499,00
FILTRO AR. LAM. SUN D.1200		3.679,00	3.679,00	3.999,00
FILTRO AR. LAM. SUN D.1400	4.241,00	4.661,00	4.979,00	4.979,00
FILTRO AR. LAM. SUN D.1600	5.323,00	5.545,00	5.545,00	5.785,00
FILTRO AR. LAM. SUN D.1800	6.530,00	6.824,00	7.336,00	7.447,00
FILTRO AR. LAM. SUN D.2000	7.656,00	7.913,00	8.509,00	8.679,00

BATERÍAS DE 5 VALVULAS



TIPO TYPE	PVP €
BATERÍA 5 VALVULAS DN 75	1.192,00
BATERÍA 5 VALVULAS DN 90	1.424,00
BATERÍA 5 VALVULAS DN 110	1.590,00
BATERÍA 5 VALVULAS DN 125	1.906,00
BATERÍA 5 VALVULAS DN 140	2.084,00
BATERÍA 5 VALVULAS DN 160	2.771,00
BATERÍA 5 VALVULAS DN 200	3.797,00

	TIPO TYPE	CV HP	PVP € Monof/Single ph	PVP € Trif/Three ph
--	--------------	----------	--------------------------	------------------------



BOMBAS DOSIFICADORAS

PL 23			320,00	-
PL 50			521,00	-
PL 75			543,00	-
DOSING KIT PH 1,5 lts a 1,5 bar			683,00	-
DOSING KIT RX 1,5 lts a 1,5 bar			683,00	-



POOLMATIC BOMBAS LIMPIAFONDOS AUTOMÁTICO

POOLMATIC 30 / 50	0,75	386,00	366,00
POOLMATIC 40 / 50	1	450,00	461,00

BOMBAS SOPLANTES



BLOWER 80-400	0,6	606,00	606,00
BLOWER 140-850	1,2	760,00	760,00
BLOWER 140-131	1,8	810,00	810,00
BLOWER 210-131	1,8	891,00	891,00
BLOWER 210-151	2	983,00	-
BLOWER 210-161	2,2	-	943,00
BLOWER 315-221	3	-	1.378,00
BLOWER 315-301	4	-	1.539,00

TIPO
TYPE

PVP €



A. CAÑON RIVA PLANO	306,00
B. CAÑON RIVA REDONDO	313,00
C. CASCADA RIMINI	1.650,00
D. CASCADA ALDARA + ANCLAJE	1.880,00
E. CASCADA ALDARA MINI	1.000,00
F. CAÑON DOLCE 350 SATINADO	1.648,00
G. PULSADOR PIEZOELECTRICO AISI316 + CABLE	136,00



G

F





H



I



J

H. INTERCAMBIADOR CALOR SS-45 (20KW)	510,00
H. INTERCAMBIADOR CALOR SS-70 (40KW)	556,00
H. INTERCAMBIADOR CALOR SS-130 (60KW)	575,00
H. INTERCAMBIADOR CALOR SS-180 (80KW)	805,00
H. INTERCAMBIADOR CALOR SS-250 (120KW)	832,00
H. INTERCAMBIADOR CALOR SS-300 (160KW)	988,00
H. INTERCAMBIADOR CALOR SS-500 (200KW)	1.304,00
H. INTERCAMBIADOR CALOR SS-1000 (340KW)	2.115,00
I. INTERCAMBIADOR CALOR TITANIO TI-250 (20-80KW)	1.470,00
I. INTERCAMBIADOR CALOR TITANIO TI-350 (120-160KW)	1.654,00
I. INTERCAMBIADOR CALOR TITANIO TI-500 (200KW)	1.960,00
I. INTERCAMBIADOR CALOR TITANIO TI-750	2.503,00
I. INTERCAMBIADOR CALOR TITANIO TI-1000	3.014,00
J. FRONTAL SIMPLE 316L PREPARADO PARA PIEZ.	1.112,00
J. FRONTAL SIMPLE 316L PREPARADO PARA PNEU.	1.084,00
J. FRONTAL COMPLETO 316L PREPARADO PARA PIEZ.	1.636,00
J. FRONTAL COMPLETO 316L PREPARADO PARA PNEU.	1.636,00